

User Manual



MTX100A MPEG Recorder & Player

071-1731-00

This document supports firmware version 7.00 and above.

www.tektronix.com

Copyright © Tektronix, Inc. All rights reserved. Licensed software products are owned by Tektronix or its suppliers and are protected by United States copyright laws and international treaty provisions.

Tektronix products are covered by U.S. and foreign patents, issued and pending. Information in this publication supercedes that in all previously published material. Specifications and price change privileges reserved.

TEKTRONIX and TEK are registered trademarks of Tektronix, Inc.

Contacting Tektronix

Tektronix, Inc.
14200 SW Karl Braun Drive
P.O. Box 500
Beaverton, OR 97077
USA

For product information, sales, service, and technical support:

- In North America, call 1-800-833-9200.
- Worldwide, visit www.tektronix.com to find contacts in your area.

Warranty 2

Tektronix warrants that this product will be free from defects in materials and workmanship for a period of one (1) year from the date of shipment. If any such product proves defective during this warranty period, Tektronix, at its option, either will repair the defective product without charge for parts and labor, or will provide a replacement in exchange for the defective product. Parts, modules and replacement products used by Tektronix for warranty work may be new or reconditioned to like new performance. All replaced parts, modules and products become the property of Tektronix.

In order to obtain service under this warranty, Customer must notify Tektronix of the defect before the expiration of the warranty period and make suitable arrangements for the performance of service. Customer shall be responsible for packaging and shipping the defective product to the service center designated by Tektronix, with shipping charges prepaid. Tektronix shall pay for the return of the product to Customer if the shipment is to a location within the country in which the Tektronix service center is located. Customer shall be responsible for paying all shipping charges, duties, taxes, and any other charges for products returned to any other locations.

This warranty shall not apply to any defect, failure or damage caused by improper use or improper or inadequate maintenance and care. Tektronix shall not be obligated to furnish service under this warranty a) to repair damage resulting from attempts by personnel other than Tektronix representatives to install, repair or service the product; b) to repair damage resulting from improper use or connection to incompatible equipment; c) to repair any damage or malfunction caused by the use of non-Tektronix supplies; or d) to service a product that has been modified or integrated with other products when the effect of such modification or integration increases the time or difficulty of servicing the product.

THIS WARRANTY IS GIVEN BY TEKTRONIX IN LIEU OF ANY OTHER WARRANTIES, EXPRESS OR IMPLIED. TEKTRONIX AND ITS VENDORS DISCLAIM ANY IMPLIED WARRANTIES OF MERCHANTABILITY OR FITNESS FOR A PARTICULAR PURPOSE. TEKTRONIX' RESPONSIBILITY TO REPAIR OR REPLACE DEFECTIVE PRODUCTS IS THE SOLE AND EXCLUSIVE REMEDY PROVIDED TO THE CUSTOMER FOR BREACH OF THIS WARRANTY. TEKTRONIX AND ITS VENDORS WILL NOT BE LIABLE FOR ANY INDIRECT, SPECIAL, INCIDENTAL, OR CONSEQUENTIAL DAMAGES IRRESPECTIVE OF WHETHER TEKTRONIX OR THE VENDOR HAS ADVANCE NOTICE OF THE POSSIBILITY OF SUCH DAMAGES.

Table of Contents

General Safety Summary	ix
Environmental Considerations	xi
Preface	xiii
Terms	xiii
Related Manual	xiv

Getting Started

Product Description	1-1
Standard Accessories	1-2
Optional Accessories	1-4
Options	1-4
Initial Product Inspection	1-5
Installation	1-5
Repacking for Shipment	1-9
Functional Check Procedure	1-10
Windows Operations	1-12

Operating Basics

Functional Overview	2-1
Optional Interface Cards	2-11
Basic Menu Operation	2-14
About the Data Output Source	2-17
Tutorials	2-19
Required Equipment	2-19
Outputting a Transport Stream	2-20
Recording a Transport Stream	2-22

Reference

Using the Menus	3-3
Menus in the Play Screen	3-3
Menus in the Record Screen	3-26
Toolbar Buttons	3-34
Hierarchy Display	3-37
Overview of the Hierarchy Display	3-37
Hierarchy Display Icons	3-38
Icon Text and Dialog Box	3-45
Adding Jitter to PCRs	3-53
Adding Jitter	3-53
Continuous Recording Feature	3-57
Overview	3-57
Basic Action of Continuous Recording	3-58
Performing Continuous Recording	3-59

Preset File	3-63
Contents of the Preset File	3-63
Saving a Preset File	3-63
Loading a Preset File	3-64
Connecting to a Network	3-67
Connecting the MTX100A to your PC(s)	3-67
Setting Ethernet Network Parameters	3-68
Outputting an ISDB-T Transport Stream	3-73
Syntax	3-77
SCPI Commands and Queries	3-77
IEEE 488.2 Common Commands	3-81
Remote Commands	3-83
Common Commands	3-84
DISPLAY Commands	3-86
MASS MEMORY Commands	3-86
PLAY Commands	3-88
RECORD Commands	3-100
SYSTEM Commands	3-104
Optional Commands	3-107
Default Settings	3-115
Error Message and Codes	3-119
Command Errors	3-119
Execution Errors	3-120
Device Specific Errors	3-122
Query Errors	3-122
Network Interface Specifications	3-123
Checking Remote Command Operation	3-123
Using the IEEE1394 Interface (Option 05 Only)	3-125
Note for Connections	3-125
Point-to-Point Connection	3-126
Data Probing	3-128
ASI/IEEE1394 Conversion	3-129
About the Partial Transport Stream	3-131

Appendices

Appendix A: Specifications	A-1
Performance Conditions	A-1
Functional Specifications	A-1
Electrical Specifications	A-2
Mechanical (Physical) Characteristics	A-11
Environmental Characteristics	A-11
Certifications and Compliances	A-12

Appendix B: Using the ReMux Application	B-1
Starting and Exiting ReMux	B-1
Elements of the ReMux Window	B-2
Using the ReMux Menus	B-5
ReMux Tutorials	B-8
Appendix C: Using the Scheduler Application (Option SC Only)	C-1
Starting and Exiting Scheduler	C-1
Elements of the Scheduler Application Window	C-2
Using the Scheduler Menus	C-5
Status/Control Panel	C-15
Scheduler Tutorials	C-18
Installing Scheduler on a PC	C-23
Starting and Exiting Scheduler on Your PC	C-25
Appendix D: Control Signal for Option 02	D-1
Appendix E: Defragment the Hard Disk Drive	E-1
Appendix F: Using the Recovery Discs	F-1
Reinstalling Windows XP	F-1
Reinstalling the MTX100A Application	F-2
Restoring the IEEE1394b Port Speed Setting	F-3
Appendix G: Inspection and Cleaning	G-1
Exterior Inspection	G-1
Exterior Cleaning	G-1

Glossary

Index

List of Figures

Figure 1-1: Rear-panel power connector	1-7
Figure 1-2: Front-panel ON/STBY switch	1-8
Figure 1-3: Windows Security Alert dialog box	1-8
Figure 1-4: Select File dialog box	1-10
Figure 1-5: Equipment connection for the functional check	1-11
Figure 2-1: MTX100A front panel	2-2
Figure 2-2: MTX100A rear panel	2-4
Figure 2-3: Elements of the Play screen	2-6
Figure 2-4: Play status indicator	2-7
Figure 2-5: Status bar	2-9
Figure 2-6: ASI interface	2-11
Figure 2-7: Universal parallel/serial interface	2-12
Figure 2-8: IEEE1394/ASI interface	2-13
Figure 2-9: SMPTE310M/ASI/SPI interface	2-13
Figure 2-10: Front panel showing the menu controls	2-14
Figure 2-11: Display status of the menu commands	2-15
Figure 2-12: Keypad	2-16
Figure 2-13: Select File dialog box	2-20
Figure 2-14: Hierarchy view of the transport stream file	2-21
Figure 2-15: Play status indicator	2-21
Figure 2-16: Transport stream display from an MPEG test system ...	2-22
Figure 2-17: No Signal message	2-22
Figure 2-18: Record status indicator	2-23
Figure 3-1: Select File dialog box	3-4
Figure 3-2: Clock dialog box	3-7
Figure 3-3: Set Non-TS Sync dialog box	3-9
Figure 3-4: PCR Initial Value dialog box	3-10
Figure 3-5: Start/Stop Position dialog box	3-11
Figure 3-6: Timer Play/Record dialog box	3-13
Figure 3-7: Others dialog box	3-14
Figure 3-8: IEEE1394 dialog box (Play screen)	3-21
Figure 3-9: Communication dialog box	3-23
Figure 3-10: Option Key dialog box	3-24

Figure 3-11: Status dialog box	3-25
Figure 3-12: Target dialog box	3-27
Figure 3-13: Others dialog box	3-29
Figure 3-14: IEEE1394 dialog box (Record screen)	3-32
Figure 3-15: Example of the hierarchy display	3-37
Figure 3-16: PCR Inaccuracy dialog box	3-47
Figure 3-17: PCR Inaccuracy dialog box	3-53
Figure 3-18: Jitter function with a sine jitter pattern applied	3-55
Figure 3-19: Continuous Recording check box	3-60
Figure 3-20: File counter	3-60
Figure 3-21: Save As dialog box	3-64
Figure 3-22: Open dialog box	3-65
Figure 3-23: Pin connections for a crossover Ethernet cable	3-67
Figure 3-24: Network Connections window	3-68
Figure 3-25: Local Area Connection Status dialog box	3-69
Figure 3-26: Local Area Connection Properties dialog box	3-69
Figure 3-27: Internet Protocol (TCP/IP) Properties dialog box	3-70
Figure 3-28: Hierarchy view of the ISDB-T transport stream file	3-74
Figure 3-29: ISDB-T Information dialog box	3-75
Figure 3-30: Example of SCPI subsystem hierarchy tree	3-77
Figure 3-31: Example of abbreviating a command	3-79
Figure 3-32: Example of chaining commands and queries	3-79
Figure 3-33: Example of omitting root and lower-level nodes in a chained message	3-80
Figure 3-34: Run dialog box	3-124
Figure 3-35: Telnet window	3-124
Figure 3-36: Connection example for point-to-point connection	3-126
Figure 3-37: Connection example for data probing	3-128
Figure 3-38: Connection example for ASI → IEEE1394 conversion ..	3-129
Figure 3-39: Connection example for IEEE1394 → ASI conversion ..	3-130
Figure 3-40: Partial transport stream	3-131
Figure A-1: Timing diagram of the SPI and universal parallel/serial interfaces	A-10
Figure B-1: ReMux application window	B-2
Figure B-2: Select Remux Mode dialog box	B-5
Figure B-3: OPTION dialog box	B-7

Figure B-4: Editing window for the Make S-TMCC TS mode	B-9
Figure B-5: Edit TS Information dialog box	B-10
Figure B-6: Windows displaying a transport stream icon	B-11
Figure B-7: Edit TMCC Information dialog box (S-TMCC)	B-12
Figure B-8: Editing window for the ReMux to M-TMCC TS from S-TMCC TS mode	B-13
Figure B-9: Transport stream is multiplexed	B-14
Figure B-10: Edit TMCC Information dialog box (M-TMCC)	B-15
Figure B-11: Add TMCC dialog box	B-16
Figure B-12: Editing window for the ReMux to M-TMCC TS mode .	B-18
Figure B-13: Editing window for the DeMux M-TMCC TS mode ...	B-20
Figure B-14: DEMUX dialog box	B-21
Figure C-1: Scheduler application window (schedule play mode)	C-2
Figure C-2: MTX/RTX Host Name dialog box	C-6
Figure C-3: Scheduler Settings dialog box	C-7
Figure C-4: Play Properties dialog box	C-10
Figure C-5: Save as dialog box	C-13
Figure C-6: Record Properties dialog box	C-14
Figure C-7: Status/control panel (schedule play mode)	C-15
Figure C-8: Schedule Property dialog box	C-16
Figure D-1: Timing relationship of the signals on the Universal In/Out connector	D-2
Figure E-1: Disk Defragmenter window	E-1
Figure E-2: Defragmentation Complete dialog box	E-2

List of Tables

Table 1-1: Power cord identification	1-3
Table 1-2: Environmental operating requirements	1-6
Table 1-3: AC line power requirement	1-6
Table 2-1: Tutorial recommended test equipment and accessories	2-19
Table 3-1: File menu commands (Play screen)	3-3
Table 3-2: View menu commands	3-5
Table 3-3: Play menu commands	3-5
Table 3-4: ASI I/F menu commands (Play screen)	3-19
Table 3-5: Univ I/F menu commands (Play screen)	3-20
Table 3-6: ASI/1394 menu commands (Play screen)	3-20
Table 3-7: 310M/ASI/SPI menu commands (Play screen)	3-22
Table 3-8: Utility menu commands	3-22
Table 3-9: File menu commands (Record screen)	3-26
Table 3-10: Record menu commands	3-27
Table 3-11: ASI I/F menu command (Record screen)	3-30
Table 3-12: Univ I/F menu commands (Record screen)	3-30
Table 3-13: ASI/1394 menu commands (Record screen)	3-31
Table 3-14: 310M/ASI/SPI menu command (Record screen)	3-33
Table 3-15: Toolbar button descriptions	3-34
Table 3-16: Icons used for MPEG-2, ARIB, DVB, and ATSC formats	3-38
Table 3-17: Icons specific to DVB format	3-41
Table 3-18: Icons specific to ARIB format	3-42
Table 3-19: Icons specific to ATSC format	3-44
Table 3-20: PCR Inaccuracy dialog box parameters	3-48
Table 3-21: Parameter types used in syntax descriptions	3-78
Table 3-22: BNF symbols and meanings	3-81
Table 3-23: Default Settings	3-115
Table 3-24: Command errors	3-119
Table 3-25: Execution errors	3-120
Table 3-26: Device specific errors	3-122
Table 3-27: Query errors	3-122
Table A-1: Functional specifications	A-1

Table A-2: Mainframe	A-2
Table A-3: ASI interface (Option 01)	A-5
Table A-4: Universal parallel/serial interface (Option 02)	A-6
Table A-5: IEEE1394/ASI interface (Option 05)	A-8
Table A-6: SMPTE310M/ASI/SPI interface (Option 07)	A-8
Table A-7: Mechanical characteristics	A-11
Table A-8: Environmental characteristics	A-11
Table A-9: Certifications and compliances	A-12
Table B-1: Element of the ReMux window	B-3
Table B-2: Toolbar button descriptions	B-4
Table B-3: ReMux File menu commands	B-5
Table B-4: ReMux File menu commands	B-6
Table B-5: ReMux menu commands	B-6
Table B-6: ReMux Window menu commands	B-7
Table B-7: ReMux View menu commands	B-8
Table C-1: Toolbar button descriptions	C-3
Table C-2: File menu commands	C-5
Table C-3: View menu commands	C-5
Table C-4: Schedule menu commands	C-6
Table C-5: Stream menu commands	C-9
Table D-1: Pin assignment of the Universal In/Out connector	D-1

General Safety Summary

Review the following safety precautions to avoid injury and prevent damage to this product or any products connected to it. To avoid potential hazards, use this product only as specified.

Only qualified personnel should perform service procedures.

To Avoid Fire or Personal Injury

Use Proper Power Cord. Use only the power cord specified for this product and certified for the country of use.

Ground the Product. This product is grounded through the grounding conductor of the power cord. To avoid electric shock, the grounding conductor must be connected to earth ground. Before making connections to the input or output terminals of the product, ensure that the product is properly grounded.

Observe All Terminal Ratings. To avoid fire or shock hazard, observe all ratings and markings on the product. Consult the product manual for further ratings information before making connections to the product.

Do Not Operate Without Covers. Do not operate this product with covers or panels removed.

Use Proper Fuse. Use only the fuse type and rating specified for this product.

Avoid Exposed Circuitry. Do not touch exposed connections and components when power is present.

Do Not Operate With Suspected Failures. If you suspect there is damage to this product, have it inspected by qualified service personnel.

Do Not Operate in Wet/Damp Conditions.

Do Not Operate in an Explosive Atmosphere.

Keep Product Surfaces Clean and Dry.

Provide Proper Ventilation. Refer to the manual's installation instructions for details on installing the product so it has proper ventilation.

No Power Switch. The power supply cord is considered the disconnecting device, disconnect the main power by means of the power cord.

Symbols and Terms **Terms in this Manual.** These terms may appear in this manual:



WARNING. *Warning statements identify conditions or practices that could result in injury or loss of life.*



CAUTION. *Caution statements identify conditions or practices that could result in damage to this product or other property.*

Terms on the Product. These terms may appear on the product:

DANGER indicates an injury hazard immediately accessible as you read the marking.

WARNING indicates an injury hazard not immediately accessible as you read the marking.

CAUTION indicates a hazard to property including the product.

Symbols on the Product. The following symbols may appear on the product:



CAUTION
Refer to Manual



Protective Ground
(Earth) Terminal

Environmental Considerations

This section provides information about the environmental impact of the product.

Product End-of-Life Handling

Observe the following guidelines when recycling an instrument or component:

Equipment Recycling. Production of this equipment required the extraction and use of natural resources. The equipment may contain substances that could be harmful to the environment or human health if improperly handled at the product's end of life. In order to avoid release of such substances into the environment and to reduce the use of natural resources, we encourage you to recycle this product in an appropriate system that will ensure that most of the materials are reused or recycled appropriately.



The symbol shown to the left indicates that this product complies with the European Union's requirements according to Directive 2002/96/EC on waste electrical and electronic equipment (WEEE). For information about recycling options, check the Support/Service section of the Tektronix Web site (www.tektronix.com).

Mercury Notification. This product uses an LCD backlight lamp that contains mercury. Disposal may be regulated due to environmental considerations. Please contact your local authorities or, within the United States, the Electronics Industries Alliance (www.eiae.org) for disposal or recycling information.

Restriction of Hazardous Substances

This product has been classified as Monitoring and Control equipment, and is outside the scope of the 2002/95/EC RoHS Directive. This product is known to contain lead, cadmium, mercury, and hexavalent chromium.

Preface

The user manual for the MTX100A MPEG Recorder & Player contains the following sections:

Getting Started briefly describes the MTX100A MPEG Recorder & Player and provides installation instructions, option and accessory lists, repacking instructions, and power on and off instructions.

Operating Basics provides an overview of the front panel controls and rear panel connections, operating principles, basic operating procedures, and numeric input methods. This section also provides examples of basic data outputting and recording.

Reference provides detailed information about the functions and use of the MTX100A MPEG Recorder & Player's main menus, and presents descriptions of all programming commands and the syntax used in command descriptions. This section also provides instructions for setting the network parameters for the Ethernet port.

Appendices provides product specifications, instructions for operating the ReMux and Scheduler applications, defragging the hard disk, recovering the system, and inspecting and cleaning the MTX100A MPEG Recorder & Player.

Terms

This manual uses the following terms:

- **Stream:** Generic term for transport streams and data streams of Non TS format (data format other than transport stream format).
- **S-TMCC (Single TMCC):** Transport stream to which TMCC (Transmission and Multiplexing Configuration Control) information is inserted into the 8 bytes in its Reed-Solomon code area (16 bytes). It is defined in the ISDB-S (Integrated Services Digital Broadcasting-Satellite) system.
- **M-TMCC (Multi TMCC):** Transport stream to which TMCC information is inserted into the sync byte area, and having super frame structure. It is defined in the ISDB-S system.

Related Manual

The following related documentation for the instrument is available:

- The *MTX100A MPEG Recorder & Player Service Manual* (Tektronix part number 071-1754-XX) describes how to maintain and service the MTX100A and provides a complete module-level description of the operation of the instrument. This manual is an optional accessory.



Getting Started

Getting Started

This section provides the following information:

- Product description
- List of standard and optional accessories
- List of instrument options
- Initial product inspection procedure
- Installation instructions
- Instructions for repackaging the instrument for shipment
- Functional check procedure
- Windows operations

Product Description

The MTX100A MPEG Recorder & Player records and plays MPEG-2 transport streams that are compliant with ATSC, DVB, and ARIB standards.

The MTX100A provides the following features:

- Data rate: 214 Mbps maximum; 256 Kbps minimum
- Hierarchy display of stored or captured transport stream
- 188, 204, 208 bytes packet size, S-TMCC, M-TMCC, non transport stream, and partial transport stream output formats
- Real-time updating of stream parameters; continuity_counter, PCR/PTS/DTS, TOT/TDT/STT, NPT, and Reed Solomon (ISDB-T only)
- Continuous recording of captured streams
- PCR jitter insertion
- Triggered stream capture
- Full remote control using Ethernet interface
- Scheduler application for automated stream playout and record (Option SC only)

- Optional ASI, universal parallel/serial, IEEE1394/ASI, and SMPTE310M/ASI/SPI interfaces available

The MTX100A includes the ReMux application software that provides the capability to create a transport stream of super frame structure defined in the ISDB-S systems from an MPEG2 transport stream. Refer to *Appendix B: Using ReMux Application* for detailed information about the ReMux application.

NOTE. *When inputting/outputting a stream for a long time, the stream may be intermittent because of a processing condition of the hard disk or the system process of Windows XP.*

Standard Accessories

The following accessories are shipped with the MTX100A:

Document, CD-ROMs, and Other Parts

The following document, CD-ROMs, and other parts are standard accessories:

- MTX100A MPEG Recorder & Player User Manual.
 - English (Option L0): Tektronix part number 071-1731-XX.
 - Japanese (Option L5): Tektronix part number 071-1753-XX.
- Windows XP Professional recovery DVD-ROM, Tektronix part number 063-3864-XX.
- Sample Stream CD-ROM, Tektronix part number 063-3865-XX.
- Application Software Recovery CD-ROM, Tektronix part number 063-3866-XX.
- Interface cable (D-sub 25-pin, twisted pair), Tektronix part number 012-A220-00.
- USB keyboard, Tektronix part number 119-B146-00.
- USB mouse, Tektronix part number 119-B145-00.
- Front cover, Tektronix part number 200-3897-00.

Power Cords All MTX100A MPEG Recorder & Players are shipped with one of the following power cord options. Power codes for use in North America are UL listed and CSA certified. Cords for use in areas other than North America are approved by at least one authority acceptable in the country to which the product is shipped.

Table 1-1: Power cord identification

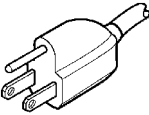
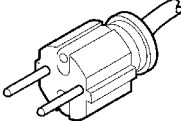
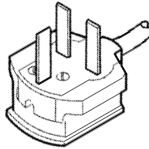
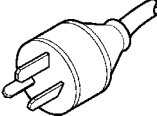
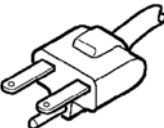
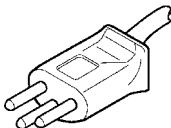
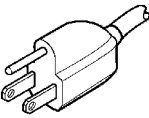
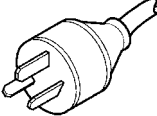
Plug configuration	Normal usage	Option number
	North America 115 V	Standard (A0)
	Universal Euro 220 V	A1
	United Kingdom 240 V	A2
	Australia 240 V	A3
	North America 250 V	A4
	Switzerland 240V	A5
	Japan 100 V	A6
	China 240 V	A10
	No power code supplied.	A99

Optional Accessories

The following items are optional accessories:

- *MTX100A MPEG Recorder & Player Service Manual*, Tektronix part number 071-1754-XX.
- WFM7F05 rackmount kit
- 1700F06 blank panel

Options

The MTX100A can be ordered with the following options:

Instrument Options

The following instrument options are available for the MTX100A:

- **Option 01:** Adds the ASI interface.
- **Option 02:** Adds the Universal Parallel/Serial interface.
- **Option 05:** Adds the IEEE1394/ASI interface.
- **Option 07:** Adds the SMPTE310M/ASI/SPI interface.
- **Option SC:** Adds the Scheduler software.

Service Options

The following service options are available for the MTX100A:

- **Option C3:** Provides calibration services for 3 years.
- **Option C5:** Provides calibration services for 5 years.
- **Option D1:** Provides calibration data.
- **Option D3:** Provides calibration data for 3 years.
- **Option D5:** Provides calibration data for 5 years.
- **Option R3:** Extends the instrument warranty to 3 years.
- **Option R5:** Extends the instrument warranty to 5 years.

Power Cord Options

See Table 1-1 on page 1-3.

Initial Product Inspection

Perform the following product inspection procedure when you receive your instrument:

1. Inspect the shipping carton for external damage, which indicates possible damage to the instrument.
2. Remove the MTX100A from the shipping carton.
3. Check that the instrument has not been damaged in transit. The exterior should not have any scratches or impact marks. Prior to shipment the instrument is thoroughly inspected for mechanical defects.

NOTE. Save the shipping carton and packaging materials for instrument repackaging in case shipment becomes necessary.

4. Verify that the shipping carton contains the instrument, the standard accessories, and any optional accessories that you ordered.
5. Perform the functional check procedure (refer to *Functional Check Procedure* on page 1-10) after installing the instrument.

Contact your local Tektronix Field Office or representative if there is a problem with your instrument or if your shipment is incomplete.

Installation

Before you install the instrument, refer to the *General Safety Summary* section at the front of this manual for power source, grounding, and other safety information.

Environment Operating Requirements

Verify that the location of your installation has the proper operating environment.



CAUTION. Damage to the instrument can occur if this instrument is powered on at temperatures outside of the specified temperature range.

Table 1-2: Environmental operating requirements

Characteristics	Specifications
MTX100A ambient temperatures	from +5 °C to + 40 °C
MTX100A relative humidity	from 20% to 80%
Clearance on top	5.0 cm (2 in)
Clearance on left side	5.0 cm (2 in)
Clearance on right side	5.0 cm (2 in)
Clearance in rear (from the fan guard)	5.0 cm (2 in)

NOTE. *If you are installing the instrument in a dedicated rack, refer to the instruction sheet that comes with the rackmounting kit for proper installation procedures.*

When the MTX100A is mounted in a 19-inch rack, verify that there is at least one unit of clearance above the MTX100A.

AC Line Voltage Requirement

Check that your location provides the proper electrical power requirements as listed in Table 1-3.

Table 1-3: AC line power requirement

Parameter	Description
Line voltage range	100 to 240 V
Line frequency	50/60 Hz
Maximum power	180 VA



CAUTION. *The instrument does not have a power switch, but does have an on/standby switch. When you connect the power cable to the AC line connector, power is applied to the power supply standby circuit of the instrument. Read all instructions on pages 1-7 and 1-8 before plugging the power cable into a power source.*

Power Cord Requirement

Refer to Table 1-1 on page 1-3 to verify that you are using the proper power cord for your location. Connect the power cord from the rear-panel power connector to the power system.



CAUTION. *The instrument is shipped with a power cord appropriate for use with your power systems (normal 115 V power system or 230 V power system). If the instrument is to be used with a power system other than that specified in the order, the power cord must be replaced with one appropriate for the power source used. Refer to Table 1-1 for a listing of available power cords.*

Applying Power to the Instrument

After you have verified the operating environment, AC line, and power cord requirements, plug the power cord into the power connector on the rear panel (see Figure 1-1), and then plug the power cord into the local power source.

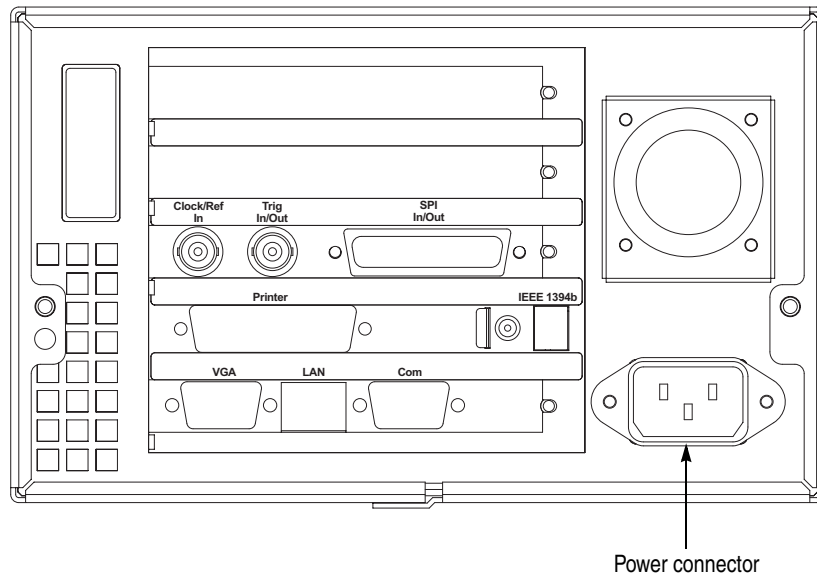

Figure 1-1: Rear-panel power connector

NOTE. To make a selection in a Windows dialog box after you power on the instrument, connect a mouse to the USB connector on the front panel before you power on.

Power On. Press the ON/STBY switch (see Figure 1-2) to power on the instrument. After you power on the instrument, verify that the fan on the rear panel is operating. To verify that the fan is operating, place your hand behind the right side of the instrument. You should be able to feel the fan's air flow.



CAUTION. Do not operate the instrument if the cooling fan does not operate when you turn the instrument on. Serious damage to your instrument can occur from overheating if the cooling fan is not operating.

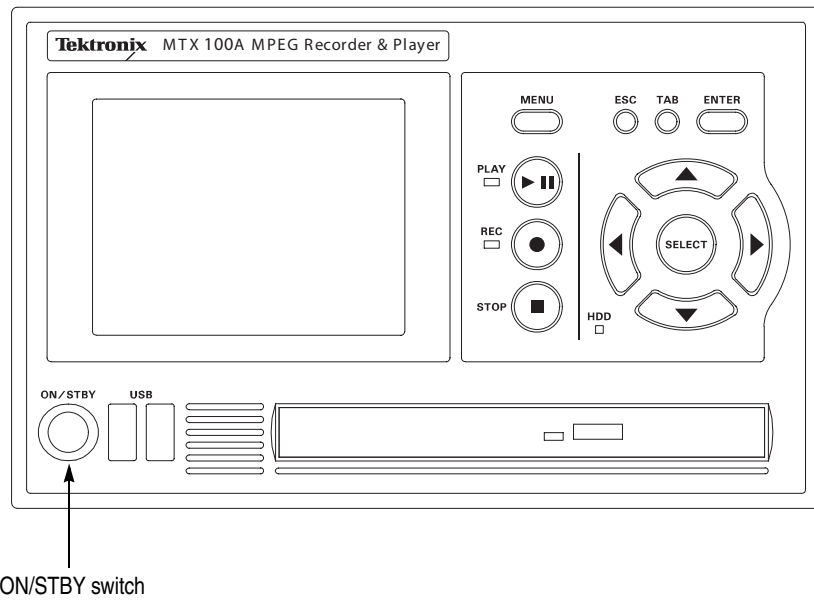

Figure 1-2: Front-panel ON/STBY switch

The first time you power on the instrument, the **Windows Security Alert** dialog box appears as shown in Figure 1-3. This dialog box appears when a program tries to use the resources or the ports on the system that are covered by the firewall.



Figure 1-3: Windows Security Alert dialog box

Click the **Unblock** button so that Windows allows the program (MPEG Series Application) to run.

When you click the Unblock button, the MTX100A application window (Play screen) is displayed.

Repacking for Shipment

When you ship this instrument, use the original packaging material if possible. If the original packaging is unfit for use or is not available, repackage the instrument using the following procedure:

1. Obtain a corrugated cardboard shipping carton having inside dimensions at least six inches greater than the instrument dimensions and having a carton test strength of at least 125 kg (275 pounds).
2. If the instrument is being shipped to a Tektronix Service Center for repair or calibration, attach a tag to the instrument showing the following information:
 - The owner of the instrument (with address).
 - The name of a person at your firm who may be contacted if additional information is needed.
 - The complete instrument type and serial number.
 - A description of the service required.
3. Wrap the instrument with polyethylene sheeting or equivalent to protect the outside finish and prevent entry of packing materials into the instrument.
4. Cushion the instrument on all sides by tightly packing dunnage or urethane foam between the carton and the instrument, allowing for three inches (7.62 cm) of padding on each side (including top and bottom).
5. Seal the carton with shipping tape or with an industrial stapler.
6. Mark the address of the Tektronix Service Center and your return address on the carton in one or more prominent locations.

Functional Check Procedure

Perform the following procedure if you are operating the instrument for the first time (to verify that the instrument shipped without damage) or you suspect that the instrument is not working properly:

NOTE. Before you perform this procedure, install the MTX100A using the instructions listed in Installation starting on page Up Windows XP Professional.

1. Connect the MTX100A to a power source, and then turn the instrument on using the **ON/STBY** switch.
2. Press the front-panel **MENU** button to display the File menu command list.
3. Press the up (▲) or down (▼) arrow button to select **Open** from the list, and then press the **ENTER** button to open the Select File dialog box shown in Figure 1-4.

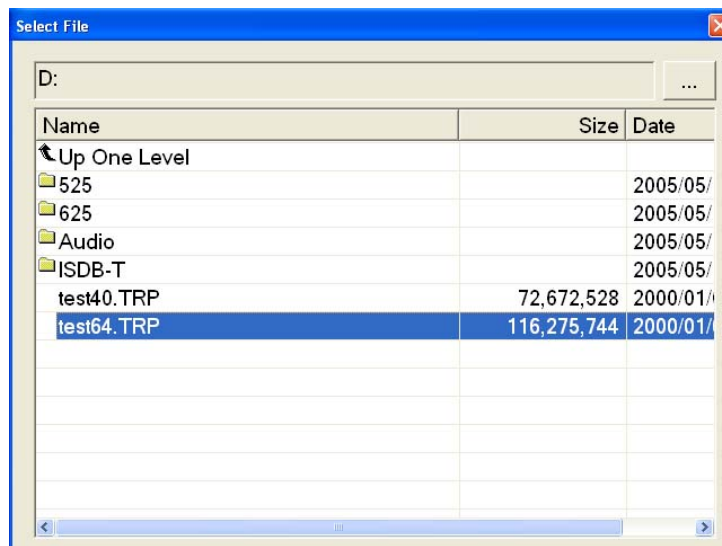

Figure 1-4: Select File dialog box

4. Press the up (▲) or down (▼) arrow button to select the **test64.TRP** file, and then press the **ENTER** button. The hierarchy view of the transport stream file will be displayed on the screen.

NOTE. You can select the *test40.TRP* file in step 4 of this procedure if you need to decrease the bit rate of the transport stream due to performance restrictions in your decoder.

5. Connect the interface cable provided with the instrument between the **SPI IN/OUT** connector on the MTX100A rear panel and the **SPI IN** connector on an MPEG decoder. See Figure 1-5.
6. Connect the decoder to a picture monitor.
7. Press the MTX100A **PLAY** button to start the transport stream output. When transport stream output is started, the Play Status indicator appears on the screen.
8. Check that the picture from the transport stream is displayed correctly on the picture monitor.

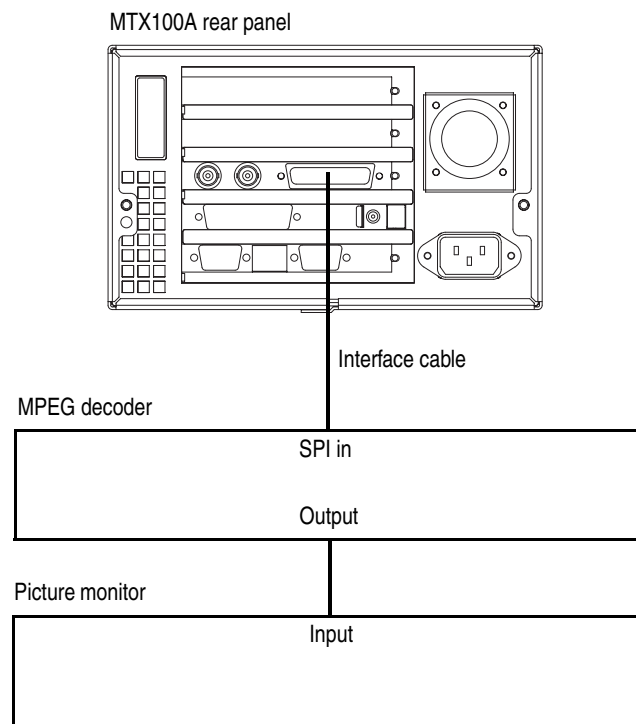

Figure 1-5: Equipment connection for the functional check

Windows Operations

All of the functions of the MTX100A are performed as an application (MTX100A application) on the Windows XP operating system. Therefore, if you connect the keyboard and mouse provided with the instrument to the front-panel USB connectors, you can operate the MTX100A system with the same environment as a Windows PC.

Operation on the Play/Record Screen

When you have connected a keyboard and mouse to the instrument, you can use them to make menu selections and parameter settings in the Play/Record screen. These operations behave in the same manner as the other Windows applications.

Displaying the Windows Screen (Desktop)

To display the Windows screen (Desktop), select Minimize or Exit from the File menu in the Play screen or Record screen. For Minimize, the MTX100A application window minimizes and the Windows XP desktop appears. For Exit, the MTX100A application exits and the Windows XP desktop appears.

File Operation

There are no menu commands to manage file operations in the MTX100A application. Perform the file operations such as copy, delete, or upload/download on Windows. Refer to Windows XP Online Help or other documentation about file operations.

The MTX100A application is placed in the C:\ProgramFiles\Tektronix\Mpeg Player folder. The sample transport stream files (test64.TRP and test40.TRP) are placed on D: drive (Volume D).

System Settings

This manual describes only the settings for connecting to an Ethernet network. Refer to Windows XP Online Help or other documentation about other system settings.



Operating Basics

Operating Basics

This section explains the basics of operating the MTX100A. The information is divided into the following subsections:

- *Functional Overview* contains descriptions of the front-panel controls, the rear-panel connectors, and elements of the display.
- *Optional Interface Cards* describes the connectors and their function of each of the optional interface cards.
- *Basic Menu Operation* provides the basic concepts of how to operate the MTX100A using the menus and front-panel buttons, and how to enter numeric input into dialog boxes.
- *Tutorials* contains procedures that show you how to output and record a transport stream.

Functional Overview

This subsection contains descriptions of the front-panel controls and the rear-panel connectors.

Front-panel Controls

Figure 2-1 shows the locations of the front-panel controls.

ON / STBY Power Switch. Powers on or off the instrument.



CAUTION. *If you power off the instrument using the ON/STBY power switch, the current instrument settings are not saved (this operation corresponds to an emergency shutdown in Windows XP). To prevent data loss, use the Shutdown command from the File menu to power off the instrument.*

USB Connectors. USB 2.0 connectors to connect the keyboard and mouse provided with the instrument for Windows operations. You can also connect other USB devices.

DVD±RW Drive. DVD drive with capability of reading and writing to the following standards: DVD-R/RW, DVD+R/RW, and CD-R/RW.

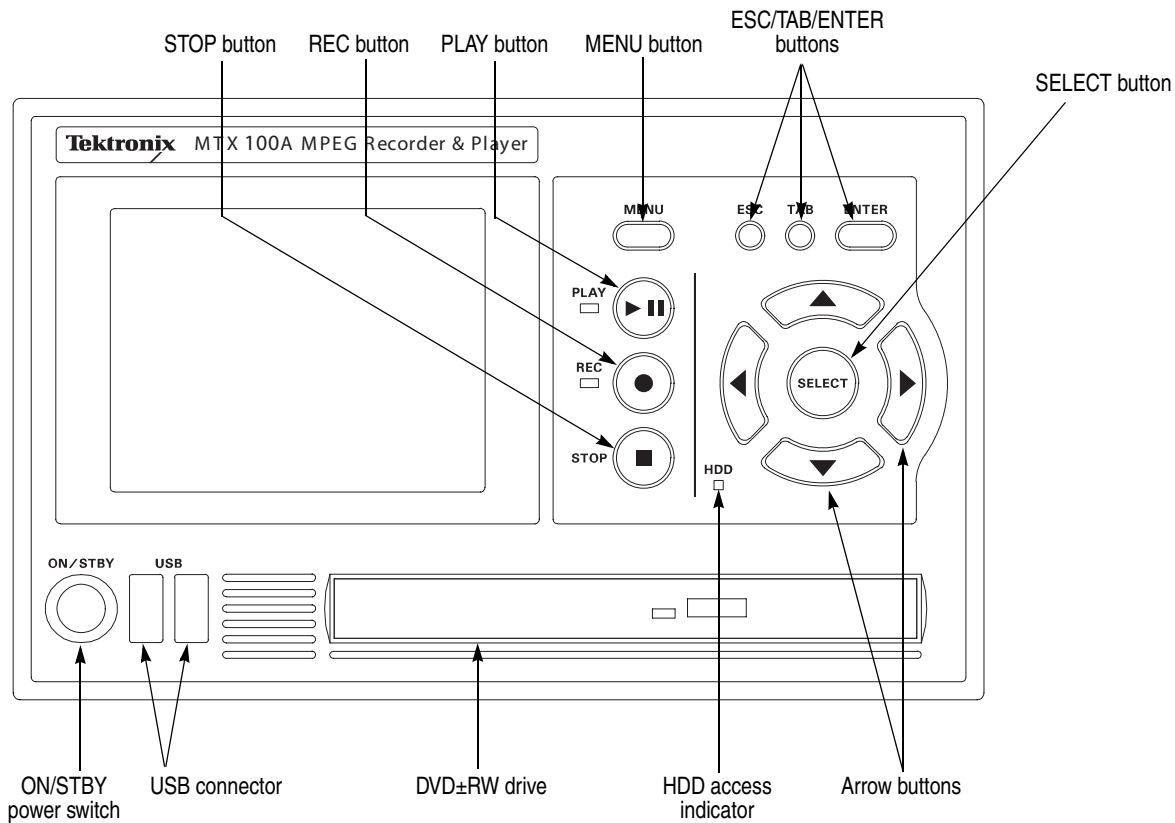

Figure 2-1: MTX100A front panel

MENU Button. Use this button to toggle the display of the menu command list on or off.

PLAY Button. Use this button to start stream output. When the Record screen is displayed, use this button to switch to the Play screen. When this button is pressed during stream output, the stream output pauses. Press the button again to start the stream output.

When an M-TMCC transport stream is selected, the MTX100A outputs the stream from the start packet in the super frame to the maximum number of packets that can be looped as an integral multiple of the number of super frames. When an ISDB-T transport stream is selected, the MTX100A outputs the stream from the start packet in the OFDM (Orthogonal Frequency Division Multiplexing) frame to the maximum number of packets that can be looped as 2 X N of the number of OFDM frames. If any transport streams within the ISDB-T transport stream have different modulation parameters, select Non TS from the Packet Size command in the Play menu (refer to page 3-5).

The status indicator at the left side of the button lights when stream data is being output. The indicator blinks when the stream output pauses.

REC Button. Use this button to record the stream data being applied. When the Play screen is displayed, use this button to switch to the Record screen.

The status indicator at the left side of the button blinks when a sync word is being detected, or when the pretrigger portion of the stream data has been recorded.

STOP Button. This button performs the following functions:

- If this button is pressed while a stream data is being output, the data output stops.
- If this button is pressed while the pretrigger portion is filled and the instrument waits a trigger event or the posttrigger portion is being recorded, the recorded data is stored in a file.

ESC/TAB/ENTER Buttons. These buttons perform the following functions:

- The ESC button is used to cancel the selected operation. When any menu command list is displayed, it closes the command list temporarily.
- The TAB button is used to move through a dialog box.
- The ENTER button is used to execute the selected menu command or enable all setting changes in a dialog box.

SELECT Button. Use the SELECT button to enable or disable any setting changes in a dialog box. It is also used to open the keypad, where you can enter numeric values for a text box.

When an ISDB-T file is selected in the Play screen or an ISDB-T signal is captured in the Record screen, pressing this button causes the ISDB-T Information dialog box to appear.

Arrow Buttons. Use the arrow buttons to maneuver on the LCD display. For example, you can use these buttons to move the Icon cursor or to move among the menu selections.

HDD Access Indicator. This indicator lights when the hard disk drive or the CD-R/RW drive is in operation.

Rear-panel Connectors

Figure 2-2 shows the locations of the MTX100A rear-panel connectors.

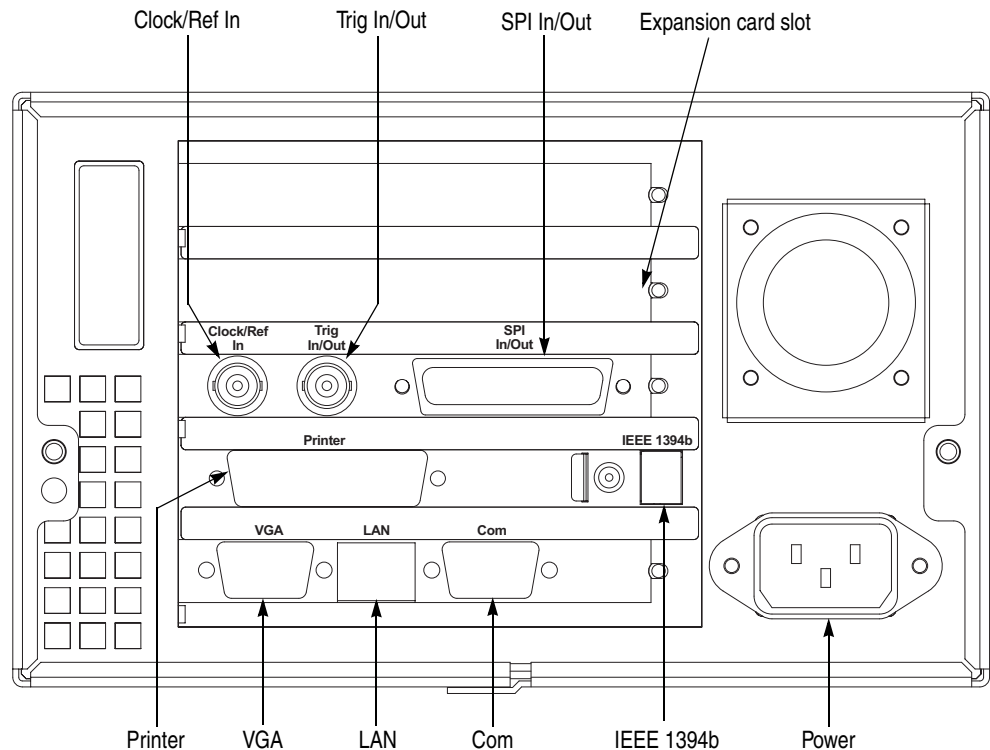

Figure 2-2: MTX100A rear panel

Expansion Card Slot. You can install one of the optional interface cards in this slot. Refer to *Optional Interface Cards* on page 2-11 for detailed information about the available interface cards.

Clock/Ref In. Use this BNC connector to input an external reference signal or clock signal. Refer to *Appendix A: Specifications* for detailed information about the signal specification.

NOTE. Use a continuous signal for an external reference or clock signal.

Trig In/Out. Use this BNC connector to input an external trigger event for stream recording or output a 27 MHz reference clock signal or an ISDB-T frame pulse signal. You can change the configuration from the Play menu (refer to the *Play Menu* on page 3-5).

Refer to *Appendix A: Specifications* for detailed information about the signal specification.

SPI In/Out. Use this 25-pin D-sub connector to input or output an SPI (Synchronous Parallel Interface) signal.

Printer. Use this 25-pin D-sub connector to connect a printer. This interface supports the IEEE 1284 parallel port standard.

IEEE1394b. Use this connector to connect an IEEE1394b device such as an external hard disk drive.

VGA. Use this 9-pin D-sub connector to display the instrument screen to an external monitor.

The VGA output is automatically enabled only when you power on the instrument with an external monitor connected. If you want to enable the VGA output after powering on the instrument, perform the following steps:

1. Minimize the Play screen to display the Windows XP desktop.
2. Click the **Intel(R) Extreme Graphics 2M** icon (see below) at the right side of the taskbar.



3. Select **Graphic Options > Output To > Intel(R) Dual Display Clone > Monitor+Notebook** from the displayed menu.

LAN. (10/100/1000 Base-T). Use this connector to connect the MTX100A to your local Ethernet network.

Com. This 9-pin D-sub connector provides a serial interface for instrument control.

Power. Use this connector to apply power to the instrument using the supplied power cord.

Display Elements

There are two types of display screens to operate the MTX100A; the Play screen and the Record screen.

- Play screen is used to output the selected stream. When you power on the instrument, this screen will display the last screen showing before powering down.
- Record screen is used to record the input stream. When you press the REC button or select the Record command from the File menu while the Play screen is displayed, the screen switches to the Record screen.

This subsection explains the display elements that make up the Play and Record screens.

Figure 2-3 shows the location of display elements of the Play screen. The display elements of the Record screen are the same as that of the Play screen.

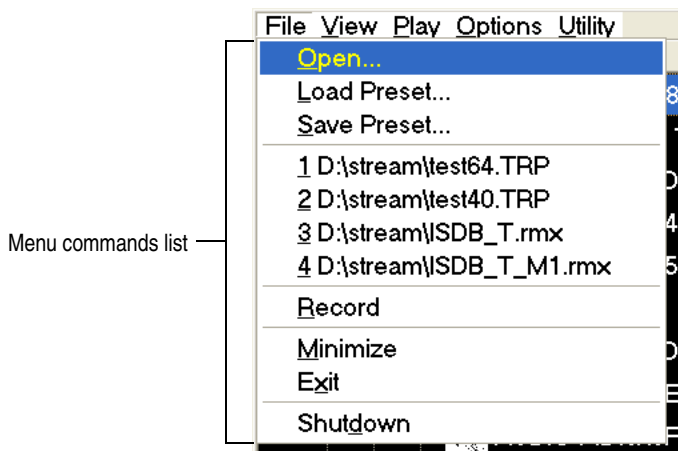
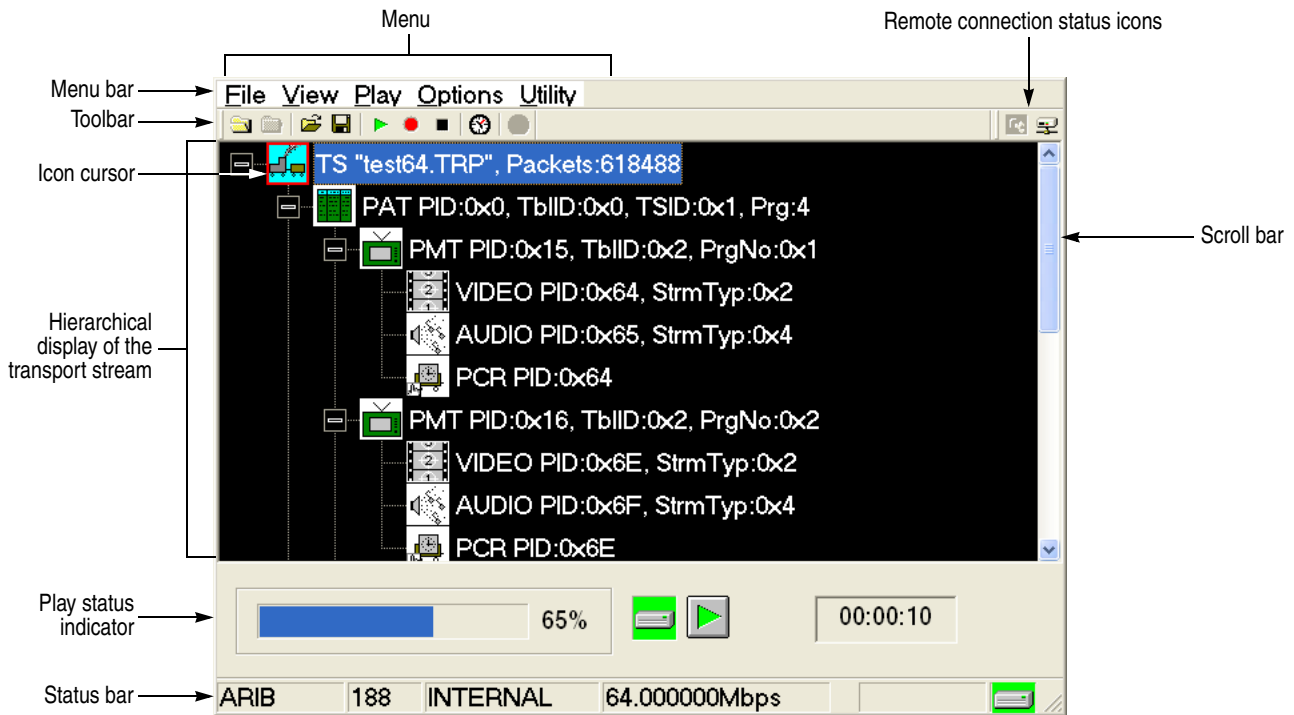

Figure 2-3: Elements of the Play screen

Menu Bar. The Menu bar displays the names of the menus that can be used in the Play or Record screen. Press the MENU button to enable or disable the menus.

Refer to *Using the Menus* on page 3-3 for detailed information about the menus.

Toolbar. The toolbar provides shortcut buttons for many of the most often used menu commands. Click a toolbar button to select the corresponding command. You can toggle the toolbar display on and off using Toolbar command in the View menu.

Refer to *Toolbar Buttons* on page 3-34 for detailed information about the function of each toolbar button.

Hierarchy Display. Each icon in the hierarchy display represents an element of the stream. The hierarchy text contains a description of the associated icon.

Refer to *Hierarchy Display* on page 3-37 for detailed information about the hierarchy icons.

Icon Cursor. The icon cursor appears as a red box around an icon in the hierarchy to indicate the currently selected icon.

Use the up (▲) or down (▼) arrow button to move the icon cursor between icons. When the icon cursor is at the top or bottom of the hierarchy display, the hierarchy scrolls to show additional elements of the stream when applicable.

Play/Record Status Indicator. The play status indicator (see Figure 2-4) is displayed while the selected stream is being output. It shows the output status of the selected stream: the progress of the stream output, the output source, the operational status, and the elapsed time.

The record status indicator is displayed while the input stream is being recorded. It shows the record status of the input stream: the progress of the stream record, the record target, and the elapsed time.

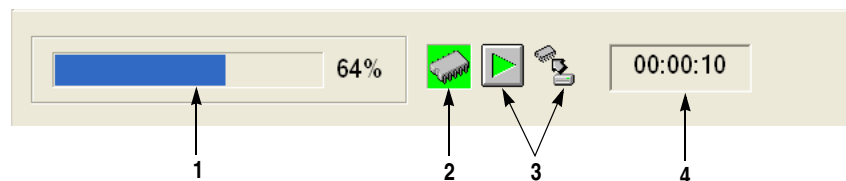

Figure 2-4: Play status indicator

The play/record status indicator shows the following information:

1. **Position Indicator.** In the Play screen, this indicator shows the progress of the stream output using the duration gauge. In the Record screen, this indicator shows the progress of the stream record using the duration gauge.

The duration gauge is updated every 1 second. If you output a stream with a repetition rate of around 3 seconds, the gauge may not be displayed correctly.

2. **Output Source/Record Target.** In the Play screen, this indicator shows the output source used to output the selected stream. In the Record screen, this indicator shows the record target used to record the input stream.

Either of the following icons are displayed according to the selected output source or record target:



This icon shows that the hard disk is the output source or record target.



This icon shows that the RAM is the output source or record target.

3. **Operation Status.** Shows the current operation status of the instrument.

In the Play screen, the following icons are used:



This icon shows that the selected stream is being output.



This icon shows that the stream output is being stopped.



This icon shows that the selected stream is being read from the hard disk to the RAM.

In the Record screen, the following icons are used:



This icon shows that the captured stream is being recorded.



This icon shows that the stream record is being stopped.



This icon shows that the MTX100A waits for a trigger event.



This icon shows that a trigger event occurs.



This icon shows that the captured stream is being processed on the hard disk.



This icon shows that the captured stream is being saved from the RAM to the hard disk.

- 4. Elapsed Time.** In the Play screen, this box displays the elapsed time of the current stream data output.

In the Record screen, this box displays the elapsed time since the input stream was recorded.

Scroll Bar. The scroll bar appears when there is a hierarchy display to show the relative position of the hierarchy of the stream.

NOTE. After you scroll a hierarchy display in the Record screen, the display may be out of focus. If this is the case, select an icon cursor on the display to refocus.

Status Bar. The status bar (see Figure 2-5) contains several indicators that display general information about the transport stream output or record status.

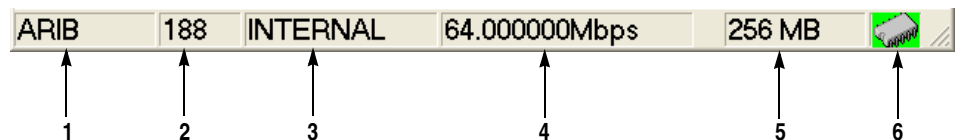

Figure 2-5: Status bar

The status bar shows the following information:

1. **Standard.** In the Play screen, this indicator shows the standard used to display the selected stream (MPEG2, ARIB, DVB, ATSC, S-TMCC, M-TMCC, or Non TS). In the Record screen, this indicator shows the standard used to display the input stream.
2. **Packet Size.** In the Play screen, this indicator displays the packet size in bytes (188, 204, 208, Non TS, or Partial TS (Option 05 only)) of the stream output. In the Record screen, this indicator displays the packet size in bytes of the input stream.
3. **Clock Source.** This indicator displays the source of the reference clock (internal or external) used for the stream output.
4. **Bit Rate.** In the Play screen, this indicator displays the bit-rate (in Mbps) of the stream output. In the Record screen, this indicator displays the bit-rate (in Mbps) of the input stream.
5. **RAM free space.** In the Play screen, this indicator shows the RAM free space that can be used to output the selected stream. In the Record screen, this indicator shows the RAM free space that can be used to record the input stream.
6. **Output Source/Record Target.** In the Play screen, this indicator shows the output source used to output the selected stream. In the Record screen, this indicator shows the record target used to record the input stream.

This indicator is the same as the output source/record target indicator of the Play/Record Status indicator.

Remote Connection Status Icons. The remote connection status icons appear when a TCP/IP connection for remote control is established. The right icon shows the status of the TCP/IP connection (this icon is always displayed when the TCP/IP connection is established), and the left icon shows the lock status of the front-panel buttons and mouse input.

There are two display states:



This shows that the TCP/IP connection for remote control is established.



This shows that the TCP/IP connection for remote control is established and the front-panel buttons and mouse input are locked by the :SYSTem:KLOCK:STATe ON command.

To reset the lock status, send the `:SYSTEM:KLOCK:STATE OFF` command or press the ESC button on the front panel (if a keyboard is connected, press the Esc key).

When the TCP/IP connection is closed, the remote status icons disappear.

Optional Interface Cards

The MTX100A is equipped with a card slot on the rear panel to install one of the following optional interface cards:

- ASI interface (Option 01)
- Universal parallel/serial interface (Option 02)
- IEEE1394/ASI interface (Option 05)
- SMPTE310M/ASI/SPI interface (Option 07)

This subsection describes these interface options and their functions.

ASI Interface (Option 01)

Figure 2-6 shows the ASI interface. Refer to *Appendix A: Specifications* for detailed specifications of the interface.

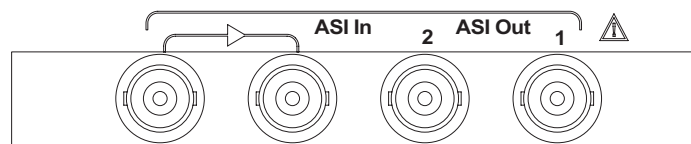

Figure 2-6: ASI interface

ASI In. Use this BNC connector to input an ASI (Asynchronous Serial Interface) signal. The left side of the connector has a loopthrough output.

ASI Out. Use this BNC connector to output an ASI (Asynchronous Serial Interface) signal.

Universal Parallel/Serial Interface (Option 02)

Figure 2-7 shows the universal parallel/serial interface. Refer to *Appendix A: Specifications* for detailed specifications of the interface.

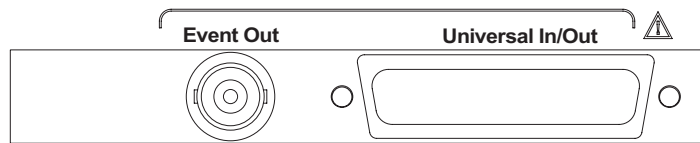

Figure 2-7: Universal parallel/serial interface

Event Out. Use this BNC connector to output an event signal. This signal is the same as the PSYNC signal of the parallel output.

Universal In/Out. Use this connector to input or output an ECL/TTL/LVDS signal in a parallel or serial format.

IEEE1394/ASI Interface (Option 05)

Figure 2-8 shows the IEEE1394/ASI interface. Refer to *Appendix A: Specifications* for detailed specifications of the interface.

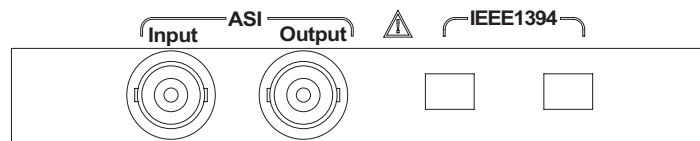

Figure 2-8: IEEE1394/ASI interface

ASI Input. Use this BNC connector to input an ASI (Asynchronous Serial Interface) signal.

ASI Output. Use this BNC connector to output an ASI (Asynchronous Serial Interface) signal. This connector outputs a signal under the following conditions:

- While a stream is being output from the IEEE1394 connector.
- While a stream is being recorded using the IEEE1394 connector.
- While a stream is being recorded using the ASI Input connector.

IEEE1394. Use these 4-pin IEEE1394 connectors to connect IEEE1394 device(s) such as a BS/CS tuner or a D-VHS recorder. Refer to *Using the IEEE1394 Interface (Option 05 Only)* on page 3-125 for detailed information on how to send or receive a transport stream using the IEEE1394 connector.

SMPTE310M/ASI/SPI Interface (Option 07)

Figure 2-9 shows the SMPTE310M/ASI/SPI interface. Refer to *Appendix A: Specifications* for detailed specifications of the interface.

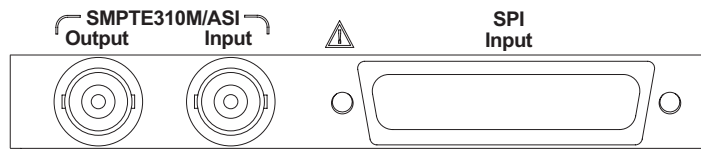

Figure 2-9: SMPTE310M/ASI/SPI interface

NOTE. The SMPTE310M interface supports the data rates of 19.392658 Mbps (8 VSB, 188 bytes packet size).

SMPTE310M/ASI Output. Use these BNC connectors to output a SMPTE310M or an ASI (Asynchronous Serial Interface) signal. You can select the output signal format from the 310M/ASI/SPI menu (refer to *310M/ASI/SPI Menu* on page 3-22).

SMPTE310M/ASI Input. Use this BNC connector to input a SMPTE310M signal or an ASI (Asynchronous Serial Interface) signal. You can select the input signal format from the 310M/ASI/SPI menu (refer to *310M/ASI/SPI Menu* on page 3-33).

SPI Input. Use this 25-pin D-sub connector to input an SPI (Synchronous Parallel Interface) signal.

NOTE. The SPI Input connector can only be used to input a signal.

Basic Menu Operation

This section describes the basics of using the MTX100A menu and the methods for entering numeric input in the various dialog boxes.

The menus are displayed in the menu bar at the top of the Play or Record screen. You can operate these menus using the front panel MENU button, ESC button, TAB button, ENTER button, and the arrow buttons (see Figure 2-10).

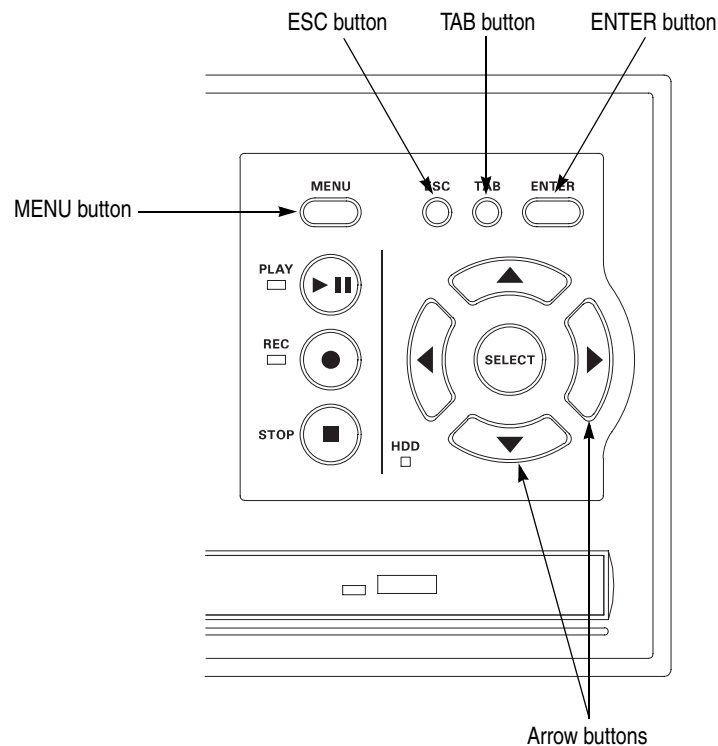

Figure 2-10: Front panel showing the menu controls

Accessing Menu Commands. To access any menu command, press the MENU button. When you press the MENU button, the File menu command list opens.

Use the up (▲) or down (▼) arrow button to move through the command list. Press the ENTER button to execute the selected command.

Use the left (◀) or right (▶) arrow button to select the desired menu. Press the ESC button to close the command list temporarily.

Press the MENU button again to close the menu command list.

NOTE. When you press the left arrow button while the File menu is displayed or when you press the right arrow button while the Utility menu is displayed, the Windows Control menu appears.

Display States of the Menu Commands. The menu commands can have the following three display states as shown in Figure 2-11:

- A command followed by “▶” indicates that a corresponding submenu will be displayed after you press the ENTER button or the right (▶) arrow button.
- A command followed by an ellipsis (...) indicates that a corresponding dialog box will open after you press the ENTER button.
- A command name by itself will be executed after you press the ENTER button.

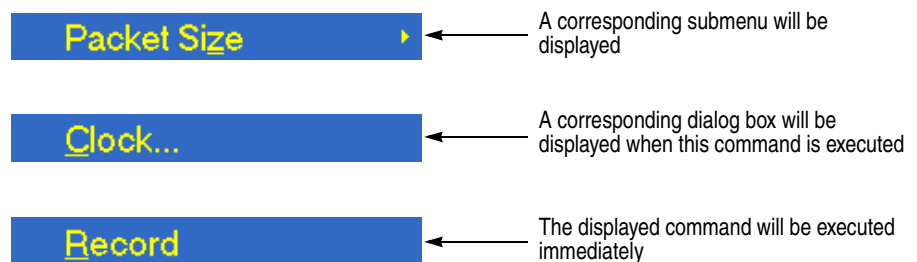

Figure 2-11: Display status of the menu commands

Numeric Input

You can enter numeric values in the displayed dialog box by using the keypad or by using the arrow buttons.

Numeric Input Using the Keypad. Perform the following procedure to input numeric values by using the keypad. Figure 2-12 shows the keypad.

1. Open a dialog box including the text box in which you want to change a parameter.
2. Press the **TAB** button repeatedly to select (highlight) the numeric parameter you want to change in the open dialog box.

3. Press the **SELECT** button to open the keypad (see Figure 2-12).

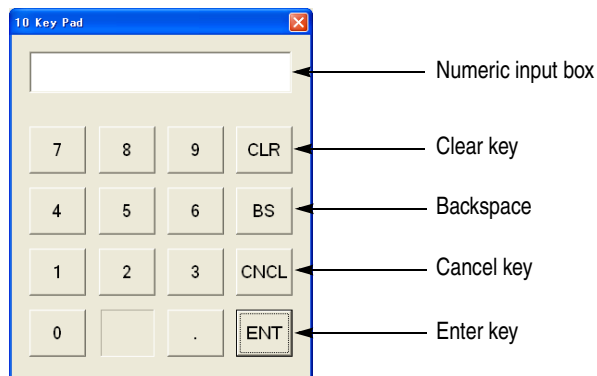

Figure 2-12: Keypad

4. Press the **TAB** button or the arrow buttons to move the dotted line box onto the number you want to input (when the keypad first opens, the box is located on the ENT key).
5. Press the **SELECT** button. This displays the selected number in the numeric input box.
6. Repeat steps 4 and 5 to input the desired parameter value.
7. Press the **ENTER** button (or select the **ENT** key and then press the **SELECT** button). This saves the new value in the numeric input box and closes the keypad.

Numeric Input Using the Arrow buttons. Perform the following procedure to change a value by using the arrow buttons:

1. Open the dialog box containing the text box where you want to change a parameter.
2. Press the **TAB** button repeatedly to select the numeric parameter you want to change in the open dialog box.
3. Press the left (◀) arrow button to begin editing the parameter. This highlights the last digit.
4. Press the left (◀) or right (▶) arrow button to move the highlighted cursor to the value you want to change.
5. Press the up (▲) or down (▼) arrow button to increase or decrease the value.
6. Repeat steps 4 and 5 to enter all of the desired values. To add a digit, press the left (◀) arrow button.

7. After you change all of the values, press the **ENTER** button.

About the Data Output Source

When you output the selected stream data, you can select either the hard disk or the RAM as the output source. This subsection describes the operation of the MTX100A when each output source is selected.

RAM When you select the RAM as the output source, the MTX100A performs the following:

- When data output rate is less than or equal to 120 Mbps, the MTX100A outputs the first stream data while transferring the data from the hard disk to the RAM and then continuously outputs the data from the RAM using looping methods.
- When data output rate is more than 120 Mbps, the MTX100A continuously outputs a stream data from the RAM using looping methods after the data is completely transferred from the hard disk to the RAM.

If you select the RAM as the output source, you cannot output the data over the RAM free space for the data output (maximum 256 MB). This RAM free space is displayed on the status bar. Refer to *Status Bar* on page 2-9, for more information about the status bar.

Hard Disk If you select the hard disk (Disk) as the output source, the MTX100A always outputs the selected stream data from the hard disk regardless of the data output rate. When the reading speed of the hard disk cannot overtake the data output rate, the error message “Error: Output Buffer Empty” appears.

Use the Source command in the Play menu to select the output source. Refer to *Play Menu* on page 3-5 for more information about the Play menu.

You can see the currently selected output source in the status bar. Refer to *Status Bar* on page 2-9, for more information about the status bar.

Tutorials

This section provides the following tutorials to familiarize you with the basic functions of the MTX100A:

- Outputting a transport stream
- Recording a transport stream

NOTE. *These tutorials do not cover all the features and functions of the MTX100A. The tutorials are intended to introduce you to the operations required to execute the instrument's basic functions.*

Refer to the Reference section for detailed descriptions of the menus and functions used in these procedures.

Before you perform these tutorials, make sure that the MTX100A is properly installed. Refer to Installation on page 1-5.

Required Equipment

Table 2-1 lists the equipment required to perform the tutorials. Accuracy of alternate equipment should equal or exceed that of the example instruments and accessories. Using inadequate equipment may result in inaccurate measurements.

Table 2-1: Tutorial recommended test equipment and accessories

Item	No.	Requirement	Example
MPEG test system	1	Real-time transport stream analyzer	Tektronix MTS400 Series MPEG Test Systems or equivalent
Interface cable	1	D-sub, 25 pin	Tektronix part number 012-A022-00 (provided with the instrument)

Outputting a Transport Stream

The hard disk drive of the MTX100A is shipped with files containing factory-supplied samples of transport streams. This tutorial opens one of these sample files and outputs the transport stream.

Perform the following steps to select and output a stored transport stream:

1. Press the front-panel **PLAY** button to display the Play screen.
2. Press the **MENU** button to open the **File** menu.
3. Press the up (▲) or down (▼) arrow button to select **Open** from the menu, and then press the **ENTER** button to open the Select File dialog box shown in Figure 2-13.

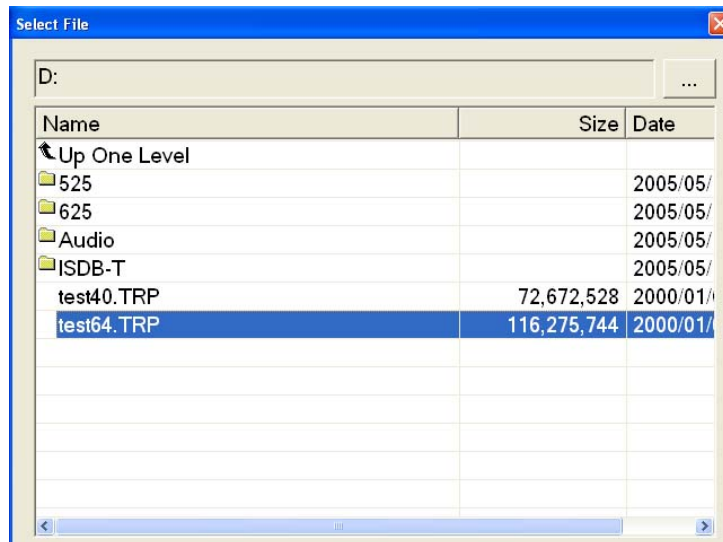

Figure 2-13: Select File dialog box

4. Press the up (▲) or down (▼) arrow button to select the **test64.TRP** file, and then press the **ENTER** button. This displays the hierarchy view of the transport stream file shown in Figure 2-14.

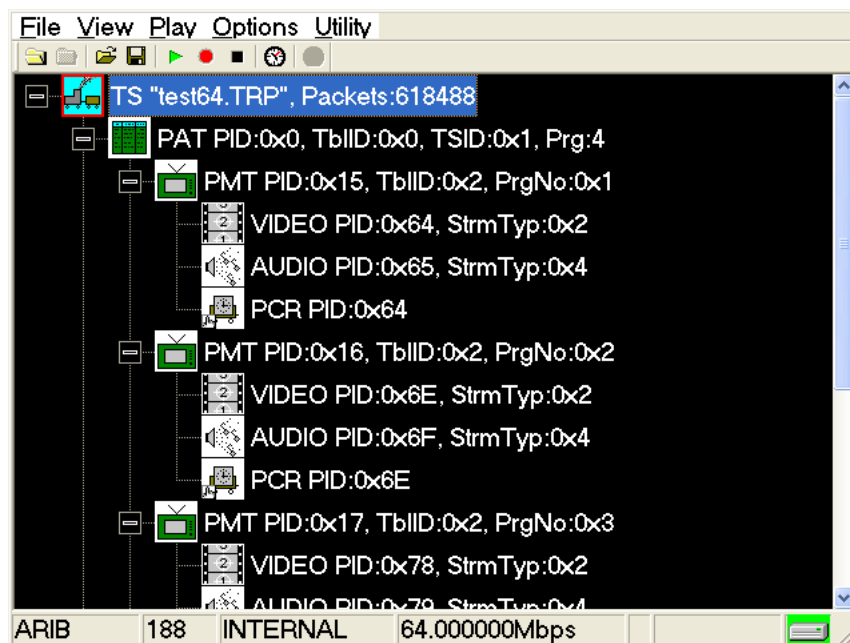

Figure 2-14: Hierarchy view of the transport stream file

5. Connect the interface cable between the **SPI In/Out** connector on the MTX100A rear panel to the **SPI In** connector of the MPEG test system.
6. Press the MTX100A **PLAY** button to start the transport stream output.

When transport stream output is started, the play status indicator (see Figure 2-15) appears and the PLAY indicator at the left side of the button lights.

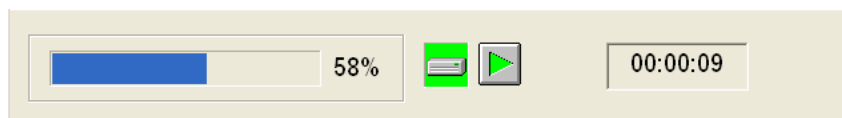

Figure 2-15: Play status indicator

7. Set up the MPEG test system to monitor the transport stream output from the MTX100A. Figure 2-16 shows the transport stream data displayed on an MPEG test system.
8. Press the **STOP** button on the MTX100A to stop the transport stream output. Observe that the Play Status indicator disappears.

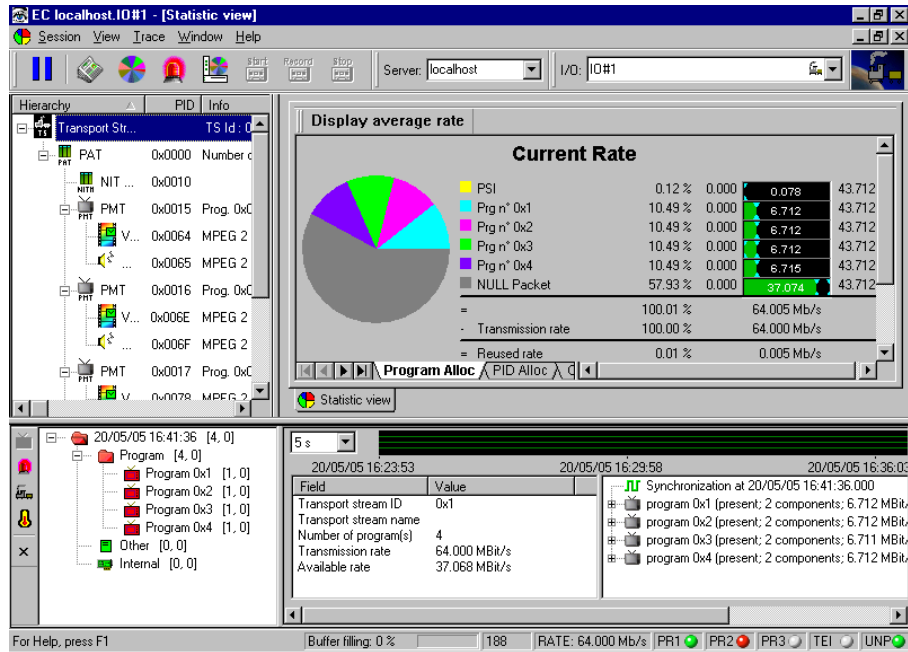

Figure 2-16: Transport stream display from an MPEG test system

Recording a Transport Stream

This tutorial captures a transport stream being applied into the SPI In/Out connector and records it on the hard disk as a file.

Perform the following steps to capture a transport stream and record it in the hard disk as a file:

1. Press the front-panel **REC** button to display the Record screen.

Since no signal is being applied at this time, the No Signal message appears on the top of the screen (see Figure 2-17).

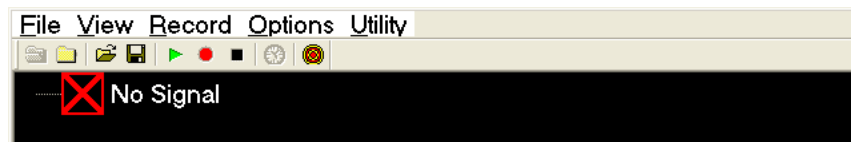

Figure 2-17: No Signal message



CAUTION. Connect the interface cable before applying a signal to the SPI In/Out connector. If you connect the cable while a signal is being output, the MTX100A may not function correctly.

2. Connect the interface cable between the **SPI In/Out** connector on the MTX100A rear panel to the **SPI** connector of the MPEG test system.
3. Output a transport stream from the MPEG test system.

When transport stream output is started, the hierarchy view of the transport stream is displayed on the Record screen of the MTX100A.

4. Press the MTX100A **REC** button.

When you press the button, the record status indicator (see Figure 2-18) appears and the REC indicator at the left side of the button lights.

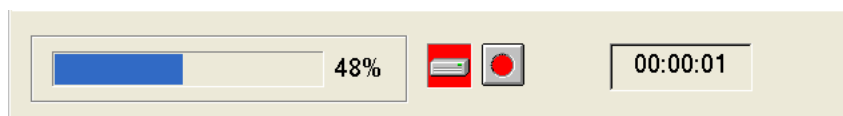

Figure 2-18: Record status indicator

After the transport stream record is completed, the record status indicator disappears, and the transport stream is saved automatically with a file name which shows the current date (yy:mm:dd).



Reference

Reference

The Reference section is divided into the following subsections:

- *Using the Menus* describes the function of each selection available in the menus.
- *Hierarchy Display* describes the icons used by the MTX100A to represent transport stream elements.
- *Adding Jitter to PCRs* provides instructions and procedures on how to add jitter to PCRs.
- *Continuous Recording Feature* describes features and basic action of Continuous Recording.
- *Preset File* provides information about the preset file and procedures on how to save and load a preset file.
- *Connecting to a Network* provides procedures to connect the MTX100A to your network.
- *Outputting an ISDB-T Transport Stream* provides the procedure to output an ISDB-T transport stream from the MTX100A.
- *Syntax* defines the command syntax and processing conventions.
- *Remote Commands* provides the remote commands set used in the MTX100A.
- *Default Settings* lists the default settings of the remote commands.
- *Error Messages and Codes* lists the codes and messages used in the status and event reporting system in the MTX100A.
- *Network Interface Specifications* describes the MTX100A network interface specifications.
- *Using the IEEE1394 Interface (Option 05 Only)* explains how to connect the MTX100A Option 05 and an IEEE1394 device(s), and how to set up the MTX100A Option 05.

Using the Menus

This section describes the function of each selection available in the menus. This section is divided into the following subsections:

- *Menus in the Play Screen* describes all of the menu commands and their features available in the Play screen.
- *Menus in the Record Screen* describes all of the menu commands and their features available in the Record screen.
- *Toolbar Buttons* describes the toolbar buttons and their functions.

Refer to *Basic Menu Operation* on page 2-14 for information about how to operate the menus.

Menus in the Play Screen

This subsection describes the menus available in the Play screen.

File Menu The File menu in the Play screen contains commands for selecting a stream file and for loading and saving a preset file. This menu also contains commands for exiting the MTX100A application and for shutdown of the instrument. Table 3-1 describes the commands in the File menu.

Table 3-1: File menu commands (Play screen)

Command	Description
Open	Opens a stream file stored in the E: drive (volume E). When a file is selected, the MTX100A checks the packet size of the file. When it is a transport stream file, its data is output in packets. Therefore, if an incomplete packet is included at the start or end point of the file, the portion is not output. The available minimum data size is 104 Kbyte. When you select this command, the Select File dialog box appears. Refer to <i>Select File Dialog Box</i> on page 3-4 for more information.
Load Preset	Loads the specified preset file (*.set). When a preset file is loaded, the current instrument settings are changed by the file's content. Refer to <i>Preset File</i> beginning on page 3-63 for more information about the preset file.
Save Preset	Saves the current instrument settings as a preset file. Refer to <i>Preset File</i> beginning on page 3-63 for more information about the preset file.
RECORD	Switches to the Record screen.
Minimize	Minimizes the MTX100A application window.

Table 3-1: File menu commands (Play screen) (cont.)

Command	Description
Exit	Quits the MTX100A application. The MTX100A application settings are saved.
Shutdown	Quits the MTX100A application and shuts down the MTX100A.

Select File Dialog Box. When you select the Open command from the File menu, the Select File dialog box appears as shown in Figure 3-1.

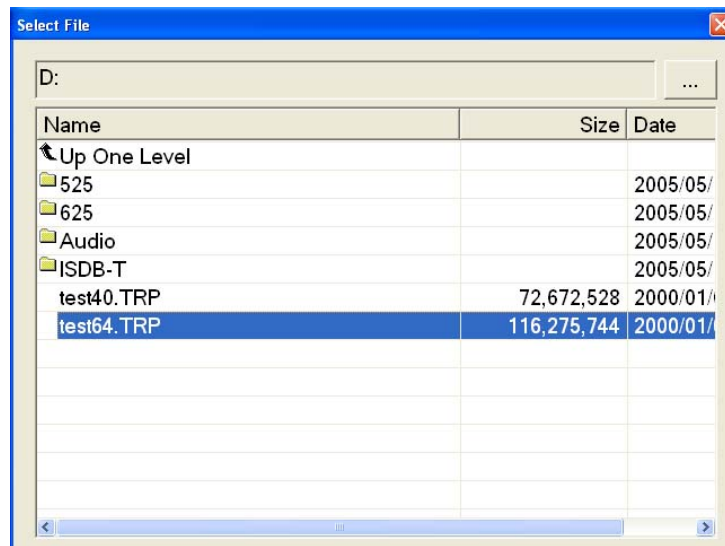

Figure 3-1: Select File dialog box

Press the arrow buttons to select the desired file, and then press the **ENTER** button to load the highlighted file.

Select **Up One Level** to move from the current directory to the directory one level higher.

When you select the “...” button at the upper right side of the dialog box, the Select File dialog box is displayed, and you can select the other file.

View Menu

The View menu contains commands that control the display of the Toolbar and Status bar. Table 3-2 describes the commands available in the View menu.

Table 3-2: View menu commands

Command	Description
Toolbar	Toggles the display of the Toolbar on and off in the Play screen. A check mark precedes the command in the menu when the Toolbar is selected for display.
Status Bar	Toggles the display of the Status bar on and off in the Play screen. A check mark precedes the command in the menu when the Status bar is selected for display.

Play Menu

The Play menu contains commands for defining output parameters such as packet size, output clock rate, or output source. Table 3-3 describes the commands available in the Play menu.

Table 3-3: Play menu commands

Command	Description
Packet Size	<p>Sets the packet size (in bytes) for the stream. You can set the packet size to 188 (188 + 0), 204 (188 + 16), 208 (188 + 20) bytes, or Non TS.</p> <p>These packet sizes can only be set for an MPEG2 transport stream. For an S-TMCC or M-TMCC transport stream, the packet size is fixed to 204. For a Non TS stream, the packet size is fixed to Non TS. In addition, if you select 8VSB for an output signal format in Option 07, the packet size is fixed to 188.</p> <p>When you select Non TS, the MTX100A deals with stream data in a byte unit (not a packet unit) and outputs all of the data in a file. If a transport stream contains any error, you can output it by selecting Non TS.</p>
Clock	Opens the Clock dialog box where you can set the clock rate of the stream output. Refer to <i>Clock Dialog Box</i> on page 3-7 for more information.
Update	<p>Sets whether to update parameters in the stream when looped. You can select On or Off. You cannot set to On for a Non TS stream.</p> <p>You can select which parameters in the stream are updated using the Others dialog box. Refer to <i>Others Dialog Box</i> on page 3-14 for more information.</p>
Sync	<p>Sets the format of the PSYNC signal output from the SPI IN/OUT connector. You can select TS Packet, SF, or Non TS. For TS Packet, a single pulse signal is output at the start point of each packet. For SF, a single pulse is output at the start point of the SF appearing every 204 X 48 X 8 bytes. For Non TS, the Set Non-TS Sync dialog box appears, where you can enable the PSYNC and DVALID signals.</p> <p>Refer to <i>Set Non-TS Sync Dialog Box</i> on page 3-9 for more information.</p>

Table 3-3: Play menu commands (cont.)

Command	Description
PCR Initial Value	<p>Opens the PCR Initial Value dialog box where you can set the initial value of the <code>program_clock_reference_base</code> and <code>program_clock_reference_extension</code> parameters when the transport stream is output.</p> <p>Refer to <i>PCR Initial Value Dialog Box</i> on page 3-10 for more information.</p>
Source	<p>Selects the source for stream output. You can select RAM or Disk.</p> <p>Refer to <i>About the Data Output Source</i> on page 2-17 for detailed information about differences between the two sources.</p>
Loop	<p>Sets whether or not the stream is output using the looping method. You can select On or Off. If you select On, the selected stream is continuously output. If you select Off, the selected stream is output once.</p>
Start/Stop	<p>Opens the Start/Stop Position dialog box where you can set the start and stop position of the stream, and initial start position of the stream for loop output.</p> <p>Refer to <i>Start/Stop Position Dialog Box</i> on page 3-11 for more information.</p>
Auto Play	<p>Sets whether or not the transport stream is automatically output using the last power-down settings when you turn on the MTX100A on. You can select On or Off. If you select On, take care of the output level setting used when the MTX100A was last turned off and the input level of the instrument (device) currently connected to the MTX100A.</p>
Timer Play	<p>Opens the Timer Play/Record dialog box where you can set the date and time used to output a stream automatically.</p> <p>Refer to <i>Timer Play/Record Dialog Box</i> on page 3-13 for more information.</p>
Other	<p>Opens the Other dialog box where you can set the standard used to display the selected stream and display radix for the text information.</p> <p>Refer to <i>Others Dialog Box</i> on page 3-14 for more information.</p>

Clock Dialog Box. When you select the Clock command from the Play menu, the Clock dialog box appears as shown in Figure 3-2.

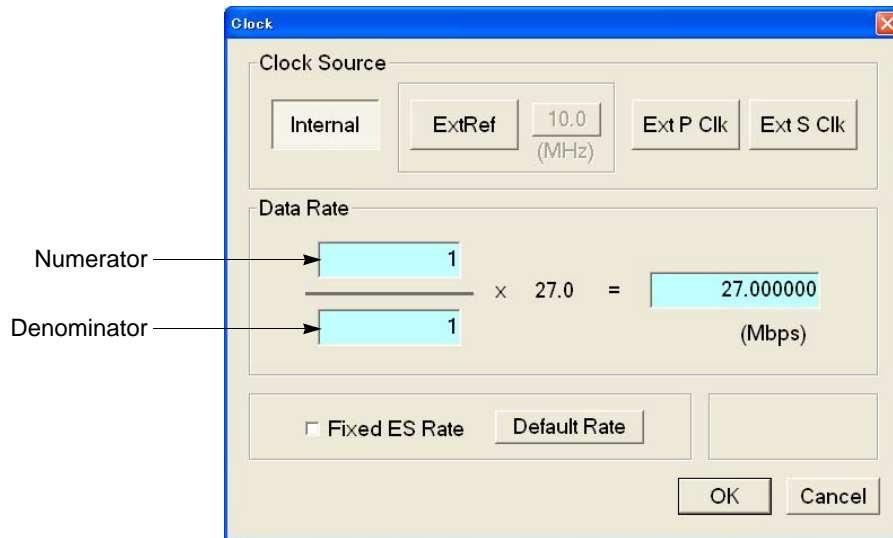
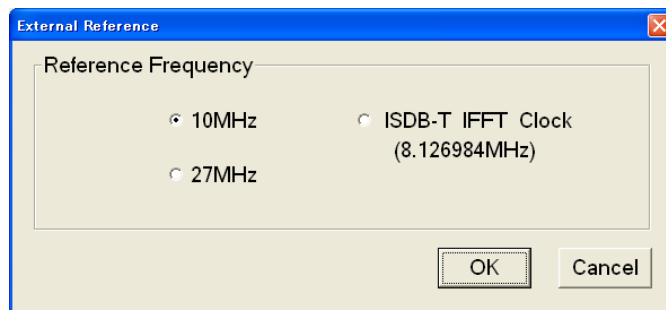

Figure 3-2: Clock dialog box

- **Clock Source:** Sets which clock will be used as the reference for the stream output. Press the **TAB** button repeatedly to select an item in the field, and then press the left (◀) or right (▶) arrow button to select the desired clock source. You can select from the following settings:

Internal uses the internal clock of the MTX100A as the clock reference.

Ext Ref allows you to input a signal on the Clock/Ref In connector for use as the clock reference. When you select the button to the right of the ExtRef box, the following External Reference dialog box appears.



- **10 MHz:** Selects a 10 MHz signal on the Clock/Ref In connector.
- **27 MHz:** Selects a 27 MHz signal on the Clock/Ref In connector.
- **ISDB-T IFFT Clock:** Selects a signal corresponding to the IFFT sample clock rate (8.126984 MHz) on the Clock/Ref In connector.

Press the **TAB** button repeatedly to select an option button, and then press the arrow buttons to select one of the options.

Ext P Clk (external parallel clock) allows you to input a clock signal on the Clock/Ref In connector for use as the parallel clock.

Ext S Clk (external serial clock) allows you to input a clock signal on the Clock/Ref In connector for use as the serial clock.

- **Data Rate:** Sets the clock rate for the transport stream output. You can enter the clock rate using the following methods (the first method provides greater clock-rate precision):

Enter values into the numerator and denominator text boxes (see Figure 3-2 on page 3-7). The MTX100A will then calculate the clock rate based on the ratio of the numerator and denominator values.

Enter a value into the clock rate text box. The MTX100A will then calculate the numerator and denominator text boxes based on the clock rate.

When you use the Ext P Clk or Ext S Clk mode, set the clock rate to the same value as the input clock signal. Also, when you use the Ext S Clk mode, you cannot set the value more than 32 Mbps.

Press the **TAB** button repeatedly to select the value you want to change, and then press the **SELECT** button to open the keypad. Use the keypad to enter the desired value.

- **Fixed ES Rate:** Sets whether the elementary stream rate is fixed or not. When it is checked, the elementary stream rate becomes constant regardless of the clock rate setting. If you fix the elementary stream rate, you cannot set the output clock rate (Data Rate) more than the data rate set when the stream file was downloaded.

Press the **TAB** button to select the check box, and then press the **SELECT** button to toggle the check box on (checked) or off (not checked).

When the Fixed ES Rate check box is enabled, PCR/PTS/DTS Update Method in the Select Update Item dialog box (see page 3-18) is set to Hardware automatically.

- **Default Rate:** Displays the default clock rate and packet size and then changes the values. When you select this button, the following Default Clock dialog box appears.

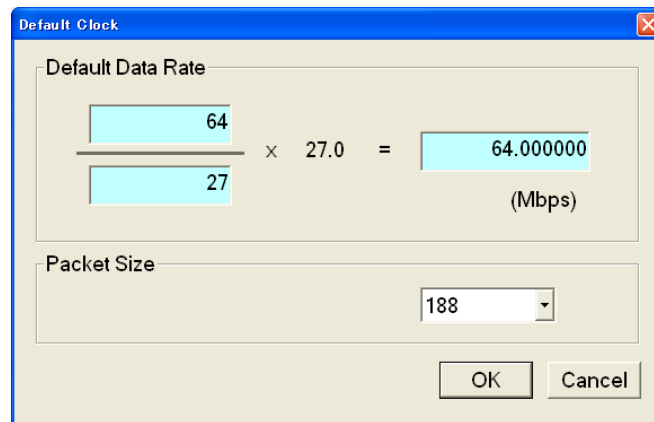

Default Data Rate: Changes the default clock rate when the selected stream file was downloaded.

Since the default clock rate is calculated based on the PCR in the downloaded stream file, the value can be different than the original clock rate. When the elementary stream rate is fixed (refer to the Fixed ES Rate description), the instrument refers to the default clock rate. Therefore, if the default clock rate is different than the original clock rate, you need to set the value to the appropriate value. If you change the value, the clock rate value in the Data Rate dialog box is also changed.

Packet Size: Changes the default packet size when the selected stream file is downloaded. If you change the value, the Packet Size setting in the Play menu will also change.

Press the **ENTER** button to enable all setting changes.

Set Non-TS Sync Dialog Box. When you select the Non-TS from the Sync command in the Play menu, the Set Non-TS Sync dialog box appears as shown in Figure 3-3.

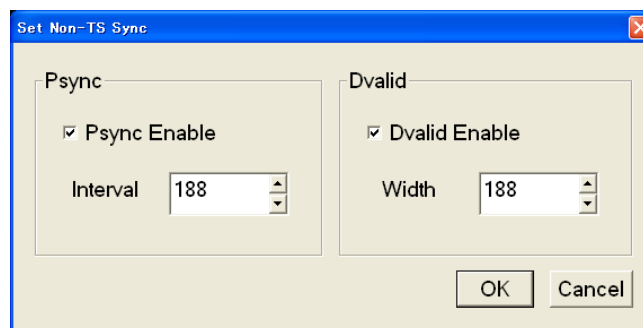

Figure 3-3: Set Non-TS Sync dialog box

- **Psync Enable:** Sets the status of the PSYNC signal output from the SPI In/Out connector. Press the **TAB** button repeatedly to select this item, and then press the **SELECT** button to toggle the check box on (checked) or off (not checked).
- **Interval:** Sets the output period of the PSYNC signal in the range of 16 to 255 bytes. This value needs to be set equal to or greater than the Width value in the Dvalid field. Press the **TAB** button repeatedly to select the box, and press the up (▲) or down (▼) arrow button to set the value.
- **Dvalid Enable:** Sets the status of the DVALID signal output from the SPI In/Out connector. Press the **TAB** button repeatedly to select this item, and then press the **SELECT** button to toggle the check box on (checked) or off (not checked).
- **Width:** Sets the data width of the DVALID signal in the range of 16 to 255 bytes. Press the **TAB** button repeatedly to select the box, and then press the up (▲) or down (▼) arrow button to set the value.

Press the **ENTER** button to enable all setting changes.

PCR Initial Value Dialog Box. When you select the PCR Initial Value command from the Play menu, the PCR Initial Value dialog box appears as shown in Figure 3-4.

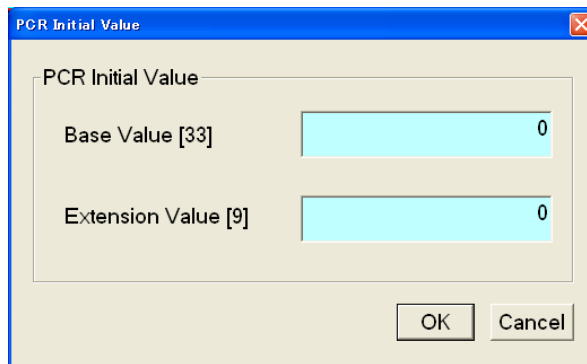

Figure 3-4: PCR Initial Value dialog box

- **Base Value:** Sets the initial value for the `program_clock_reference_base` value. You can set the value from 0 to 8589934591. The bracketed number represents the number of bits for the `program_clock_reference_base` field.

Press the **TAB** button repeatedly to select the text box, and then press the **SELECT** button to open the keypad. Use the keypad to set the desired value.

- **Extension Value:** Sets the initial value for the `program_clock_reference_extension` value. You can set the value from 0 to 299. The bracketed number represents the number of bits for the `program_clock_reference_extension` field.

Press the **TAB** button repeatedly to select the text box, and then press the **SELECT** button to open the keypad. Use the keypad to set the desired value.

Start/Stop Position Dialog Box. When you select the Start/Stop command from the Play menu, the Start/Stop dialog box appears as shown in Figure 3-5.

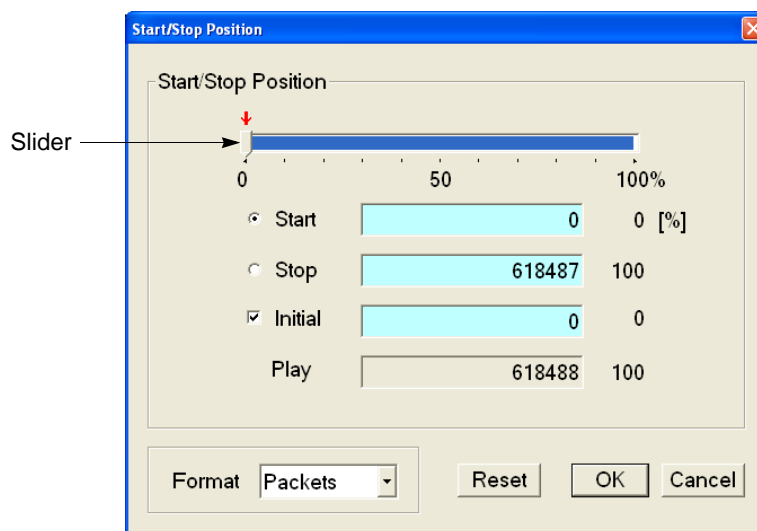

Figure 3-5: Start/Stop Position dialog box

- **Start:** Sets the start position of the stream by time (h:m:s) or the number of packets (the number of super frames for a M-TMCC file, or the number of bytes for a Non TS file). Use the Format list box to select the way to set the position.
- **Stop:** Sets the stop position of the stream by time (h:m:s) or the number of packets (the number of super frames for a M-TMCC file, or the number of bytes for a Non TS file). Use the Format list box to select the way to set the position.
- **Initial:** Sets the initial start position of the stream for loop output. You can set the value by time (h:m:s) or the number of packets (the number of super frames for a M-TMCC file, or the number of bytes for a Non TS file). Use the Format list box to select the way to set the position.
- **Play:** Shows the actual time or number of packets (the number of super frames for a M-TMCC file, or the number of bytes for a Non TS file) that is calculated by the values of the Start and Stop text boxes.

- **Format:** Specifies the way to set the start, stop, and initial positions of the stream. For a transport stream file, you can select Time or Packets. For a M-TMCC file, you can select Time or SF (super frame). For a Non TS file, you can select Time or Bytes.

For an ISDB-T file, the start packet is defined as the first-appearing packet including an OFDM frame start flag after the specified start position. The stop packet is defined as the packet at the front of the last-appearing packet including an OFDM frame start flag before the specified stop position. At this time, if the number of OFDM frames between the start packet and stop packet is not an even number, the packet in the last OFDM frame becomes the stop packet.

There are two ways to set the start, stop, and initial positions: using the slider (see Figure 3-5) to set them or using the text boxes to enter values directly.

Using the slider:

1. For the start and stop positions:
 - a. Press the **TAB** button repeatedly to select the slider. When the slider is selected, broken lines are shown around it.
 - b. Press the left (◀) or right (▶) arrow button to move the slider to the place you want to set the start position.
 - c. Press the **TAB** button repeatedly to select the Stop option button, and then press the **SELECT** button. This moves the slider to the right end.
 - d. Press the **TAB** button repeatedly to select the slider. When the slider is selected, broken lines are shown around it.
 - e. Press the left (◀) or right (▶) arrow button to move the slider to the place you want to set the stop position.
 - f. Press the **ENTER** button to enable the values.
2. For the initial start position for loop output:
 - a. Press the **TAB** button repeatedly to select the Initial check box, and then press the **SELECT** button. A red arrow appears on the slider.
 - b. Press the **TAB** button repeatedly to select the red arrow. When the arrow is selected, broken lines are shown around it.
 - c. Press the left (◀) or right (▶) arrow button to move the slider to the place you want to set the initial start position.
 - d. Press the **ENTER** button to enable the value.

Using the text boxes:

1. Press the **TAB** button repeatedly to select the Start text box. If you set a time, select one of the text boxes for setting the hour, minute, or second.
2. Press the **SELECT** button. The keypad appears.
3. Use the keypad to enter the value.
4. If you set a time, repeat step 1 through step 3 to set the hour, minute, and second.
5. Use the same procedure given in step 1 through step 4 to set the value in the **Stop** text box.
6. Press the **ENTER** button to enable the values.

To reset all of the settings to the values when the dialog box was first displayed, press the **TAB** button repeatedly to select the Reset button, and then press the **SELECT** button.

Timer Play/Record Dialog Box. When you select the Timer Play command from the Play menu, the Timer Play/Record dialog box appears as shown in Figure 3-6.

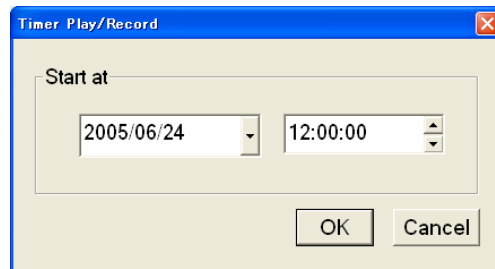

Figure 3-6: Timer Play/Record dialog box

- **Start at:** Sets the date and time when the stream output or record starts. Press the **TAB** button to select year, month, date, hour, minute, or second, and then press the up (▲) or down (▼) arrow button to set the value.

If a mouse is connected to the MTX100A, you can display a calendar for date setting by clicking the ▼ arrow button at the right side of the date display,

When you press the **ENTER** button after setting the date and time, a dialog box showing the current date and time, and set date and time is displayed. When the date and time arrives, the dialog box closes and stream output or stream record starts automatically.

If you want to cancel the operation, press the **ENTER**, **ESC**, or **SELECT** button. When the dialog box that prompts you to confirm the operation is displayed, press the **SELECT** or **ENTER** button to execute the operation.

Others Dialog Box. When you select the Other command from the Play menu, the Others dialog box appears as shown in Figure 3-7.

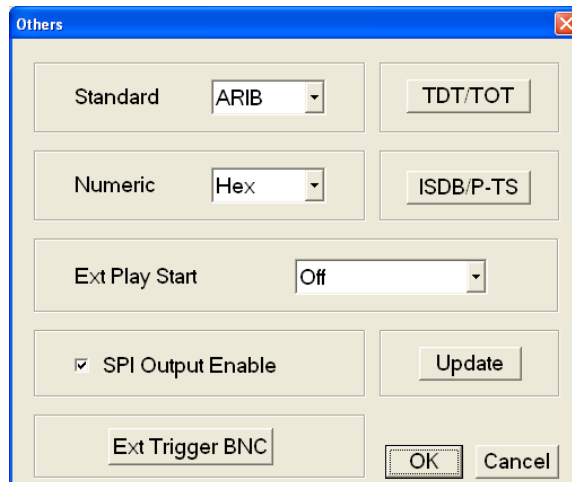

Figure 3-7: Others dialog box

- Standard:** Sets the standard used on the hierarchy-display screen. You can select ARIB, ATSC, DVB, or MPEG2. For a transport stream (ARIB, ATSC, DVB, or MPEG2), the standard is set to the previous setting as a default. For an S-TMCC, M-TMCC, or ISDB-T transport stream, you need to select ARIB for proper display.

Press the **TAB** button repeatedly to select the list box, and then press the arrow buttons to select one of the standards.

- Numeric:** Sets the base value used to describe the component information in the hierarchy display. You can select Decimal, Hex, or Octal.

Press the **TAB** button repeatedly to select the list box, and then press the arrow buttons to select one of the base values.

- Ext Play Start:** Sets whether or not to start stream output using a trigger signal applied to the Trig In/Out connector. You can select Off, Rise, or Fall. When you select Rise, the stream output is started at the rising edge of the applied trigger signal. When you select Fall, the stream output is started at the falling edge of the applied trigger signal.

Press the **TAB** button repeatedly to select the list box, and then press the arrow buttons to select one of the external play modes.

- **SPI Output Enable:** Sets whether the signal output from the SPI In/Out connector is enabled or not. Use this function to set the SPI In/Out connector to input only and the Universal In/Out connector to output only when the universal parallel/serial interface option is installed. If the Source command in the Record menu is set to STD, the signal output from the SPI In/Out connector is disabled even if you select the check box.

Press the **TAB** button repeatedly to select the check box, and then press the **ENTER** button to toggle the output on or off.

- **Ext Trigger BNC:** When you select this button, the following Ext Trigger BNC dialog box appears.

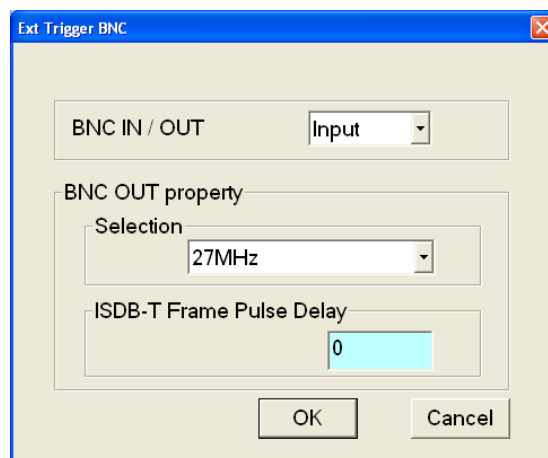

BNC IN/OUT: Sets whether to use the rear-panel Trig In/Out connector as a trigger signal input or a reference clock/ISDB-T frame clock signal output. You can select INPUT or OUTPUT. For INPUT, the Trig In/Out connector can be used to input an external trigger event. For OUTPUT, the Trig In/Out connector can be used to output a 27 MHz reference clock or an ISDB-T frame pulse signal. Use the Selection list box to select which signal is output from the connector.

Press the **TAB** button repeatedly to select the list box, and then press the arrow buttons to select either INPUT or OUTPUT.

BNC OUT property: Selects the output signal from the Trig In/Out connector when BNC Out is set to OUTPUT. You can select 27 MHz or ISDB-T Frame Pulse. If you select 27 MHz, a 27 MHz reference clock signal is output from the Trig In/Out connector. Use this option to check the clock frequency accuracy. If you select ISDB-T Frame Pulse, an ISDB-T frame pulse signal is output from the Trig In/Out connector.

Press the **TAB** button repeatedly to select the list box, and then press the arrow buttons to select either as the output signal.

ISDB-T Frame Pulse Delay: Sets the amount of delay for the start packet pulse of the ISDB-T frame in 1-parallel clocks of the SPI output. You can set the value from 0 to 15.

- **TDT/TOT or STT:** When you select this button, the following TDT/TOT dialog box appears. The button name changes which standard is selected in the Standard list box; TDT/TOT for ARIB or DVB, and STT for ATSC. Use this dialog box to change the initial date and time of the TDT (Time and Data Table), TOT (Time Offset Table), or STT (System Time Table) in the selected stream.

The button is disabled when MPEG2 is selected in the Standard list box.

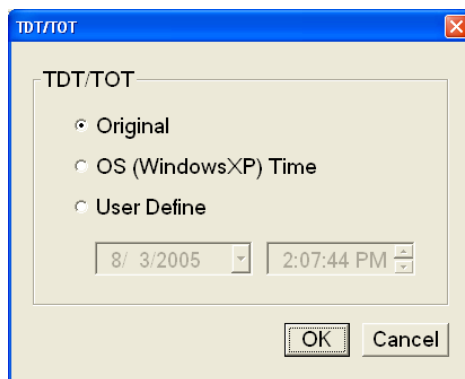

Original: Uses the original (default) value that is already defined in the selected stream.

OS (Windows XP) Time: Uses the clock/calendar of the operating system (Windows XP) to set the initial value. When you select this option, the date and time of all the TDTs, TOTs, or STTs in the selected stream are locked to the clock/calendar of the operating system.

User Define: Uses a user-defined value to set the initial value. When you select this option, the list boxes for setting the initial date and time of the TDT, TOT, or STT are available.

Press the **TAB** button repeatedly to select an option button, and then press the arrow buttons to select one of the options.

- **ISDB/P-TS:** When you select this button, the following ISDB/P-TS dialog box appears.

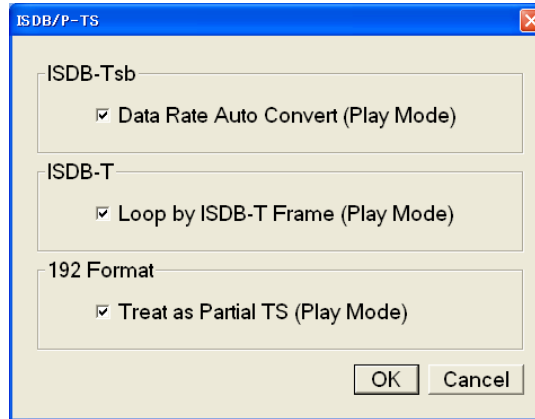

Data Rate Auto Convert (Play Mode): Sets whether to set the clock rate automatically when the ISDB-TSB file is loaded. Press the TAB button repeatedly to select this item, and then press the SELECT button to toggle the check box on (checked) or off (not checked). When it is checked, the clock rate is automatically set to $(2048/1701) \times 27$ MHz and the elementary stream rate becomes constant regardless of the Fixed ES Rate setting.

Loop by ISDB-T Frame (Play Mode): Sets whether to output the ISDB-T transport stream in OFDM frames when looped. Press the TAB button repeatedly to select this item, and then press the SELECT button to toggle the check box on (checked) or off (not checked). When it is not checked, the ISDB-T transport stream is looped in packets.

Treat as Partial TS (Play Mode): Sets whether to output a stream file consisting of a 192-byte packet as a partial transport stream. Press the TAB button repeatedly to select this item, and then press the SELECT button to toggle the check box on (checked) or off (not checked). When it is not checked, the stream is output in Non TS format.

- **Update:** When you select this button, the following Select Update Item dialog box appears. Use this dialog box to select which parameters in a stream are updated when looped.

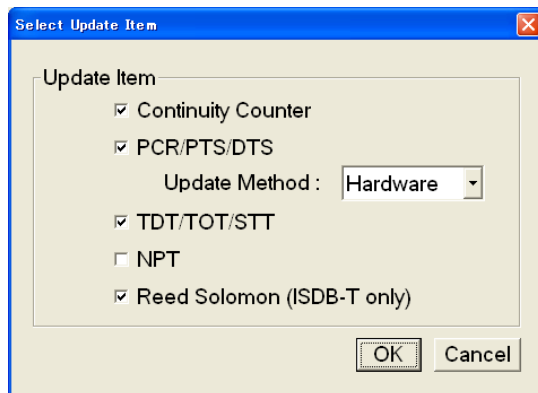

Continuity Counter: Sets whether to update continuity_counter. Press the TAB button repeatedly to select this item, and then press the SELECT button to toggle the check box on or off.

PCR/PTS/DTS: Sets whether to update PCR (Program Clock Reference), PTS (Presentation Time Stamp), and DTS (Decoding Time-Stamp). Press the TAB button repeatedly to select this item, and then press the SELECT button to toggle the check box on or off.

Update Method: Specifies the method to update PCR/PTS/DTS. You can select Software or Hardware.

- **Hardware:** PCR/PTS/DTS are updated using the counter values of the 27 MHz clock on the output board. Since data output and PCRs are completely locked, the continuity of PCRs is maintained at the loop point even if playing long stream loops. However, timing errors occur in PTS/DTS.
- **Software:** PCR/PTS/DTS are updated by adding the actual looping time (defined by the start and stop positions) to the stream every time it is looped. There are no timing errors in PTS/DTS, however, it is difficult to maintain the continuity of PCRs at the loop point because the updating is not synchronized with the 27 MHz clock on the output board. Since this method is used to update NPT, if you enable the NPT option, Software is selected automatically.

Press the **TAB** button repeatedly to select the list box, and then press the arrow buttons to select either of two methods.

TDT/TOT/STT: Sets whether to update TDT (Time & Data Table), TOT (Time Offset Table), and STT (System Time Table). Press the **TAB** button repeatedly to select this item, and then press the **SELECT** button to toggle the check box on or off.

NPT: Sets whether to update NPT (Normal Play Time; STC_Reference field in NPT Reference Descriptor defined by ISO/IEC 18318-6). Press the **TAB** button repeatedly to select this item, and then press the **SELECT** button to toggle the check box on or off.

The NPT check box is only available when PCR/PTS/DTS is enabled and the Update Method is set to Software. When the check box is enabled, PCR/PTS/DTS becomes enabled and Update Method is set to Software. In addition, the Fixed ES Rate option in the Clock dialog box becomes disabled.

Reed Solomon (ISDB-T only): Sets whether to update Reed-Solomon codes in an ISDB-T transport stream. Press the **TAB** button repeatedly to select this item, and then press the **SELECT** button to toggle the check box on or off.

Press the **ENTER** button to enable all setting changes.

ASI I/F Menu (Option 01 Only)

The ASI I/F menu is displayed when the ASI interface option is installed. This menu contains commands for setting an ASI output format and output status. Table 3-4 describes the commands available in the ASI I/F menu.

Table 3-4: ASI I/F menu commands (Play screen)

Command	Description
Format	Sets the output format of the ASI signal. You can select Byte or Packet. For Byte, valid data is output using a burst transmission mode. For Packet, valid data is output in each transport stream packet.
Through Out	Sets whether the signal supplied to the ASI In connector is output from the ASI Out connector when a stream is not output. You can select On or Off.

Univ I/F Menu (Option 02 Only)

The Univ I/F menu is displayed when the universal parallel/serial interface option is installed. This menu contains commands for setting the output signal level, output format, and polarity of the clock signal. Table 3-5 describes the commands available in the Univ I/F menu.

Table 3-5: Univ I/F menu commands (Play screen)

Command	Description
Level	Sets the signal level for the Universal In/Out connector. You can select TTL, ECL, or LVDS. Refer to <i>Appendix A: Specifications</i> for more detailed electrical characteristics.
Format	Sets the output format for the Universal In/Out connector. You can select Parallel or Serial.
Clock	Sets the polarity of the output clock signal. You can select Rise or Fall.

ASI/1394 Menu (Option 05 Only)

The ASI/1394 menu is displayed when the IEEE1394/ASI interface option is installed. This menu contains commands for setting an output format of the ASI signal and the operation mode for the IEEE1394 interface. Table 3-6 describes the commands available in the ASI/1394 menu.

Table 3-6: ASI/1394 menu commands (Play screen)

Command	Description
ASI Format	Sets the output format of the ASI signal. You can select Byte or Packet. For Byte, valid data is output using a burst transmission mode. For Packet, valid data is output in each transport stream packet.
1394 Mode	Opens the IEEE1394 dialog box where you can set connection mode when using the IEEE1394 interface. You can select only PtoP Connect (point-to-point connection) in this version. Refer to <i>IEEE1394 Dialog Box</i> on page 3-21 for more information.
Bus Reset	Resets the IEEE1394 bus. Use this command to reset the connection when the MTX100A Option 05 does not recognize an IEEE1394 device or when an IEEE1394 device does not recognize the MTX100A Option 05. NOTE: If you reset the IEEE1394 bus while the MTX100A Option 05 sends or receives data, the operation is stopped. In addition, the IEEE1394 connection is terminated.

IEEE1394 Dialog Box. When you select the PtoP Connect from the 1394 Mode command in the ASI/1394 menu, the IEEE1394 dialog box appears as shown in Figure 3-8.

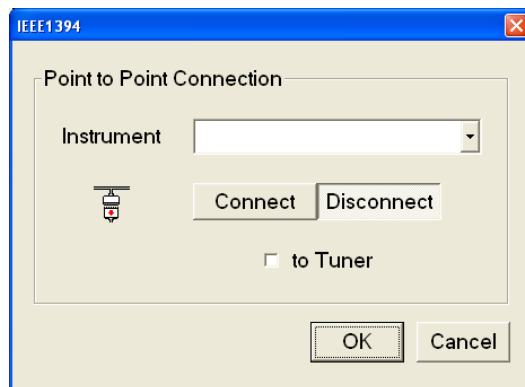

Figure 3-8: IEEE1394 dialog box (Play screen)

- **Instrument:** Selects the IEEE1394 device for the point-to-point connection.

Press the **TAB** button repeatedly to select the list box, and then press the arrow buttons to select the instrument.

- **Connect or Disconnect:** Connects or disconnects the selected IEEE1394 device.

NOTE. If bus reset occurs by disconnecting an IEEE1394 cable when the point-to-point connection is established, the connection is terminated.

- **to Tuner:** Sets whether the connection setting is made by the IEEE1394 device in connecting the MTX100A Option 05 and an IEEE1394 device.

Press the **TAB** button repeatedly to select the check box, and then press the **SELECT** button to toggle the check box on (checked) or off (not checked).

Some IEEE1394 devices do not recognize the MTX100A Option 05 when you make connection from the MTX100A Option 05. In this case, when you select the check box, the IEEE1394 device takes initiative for the connection. You need to select the check box when you connect a BS/CS tuner to the MTX100A Option 05.

Press the **ENTER** button on the front panel to enable all the settings and to close the dialog box.

**310M/ASI/SPI Menu
(Option 07 Only)**

The 310M/ASI/SPI menu is displayed when the SMPTE310M/ASI/SPI interface option is installed. This menu contains commands for setting a signal format output from the BNC connector and an output format of the ASI signal. Table 3-7 describes the commands available in the 310M/ASI/SPI menu.

Table 3-7: 310M/ASI/SPI menu commands (Play screen)

Command	Description
BNC Port	Sets the signal format output from the SMPTE310M/ASI Output connector. You can select ASI or 310M 8VSB (SMPTE310M signal with data rate of 8 VSB).
Through Out	Sets whether the signal supplied to the SMPTE310M/ASI Input connector is output from the SMPTE310M/ASI Output connector when a stream is not output. You can select On or Off.
ASI Format	Sets the output format of the ASI signal. You can select Byte or Packet. For Byte, valid data is output using a burst transmission mode. For Packet, valid data is output in each transport stream packet.

Utility Menu

The Utility menu contains commands for setting the parameters for remote control with the Ethernet interface and for displaying the system information such as software and hardware versions. Table 3-8 describes the commands available in the Utility menu.

Table 3-8: Utility menu commands

Command	Description
Communication	Opens the Communication dialog box where you can set the port number needed to remotely control the MTX100A over an Ethernet network and the terminator used to communicate with a controller. Refer to <i>Communication Dialog Box</i> on page 3-23 for more information.
Option Key	Opens the Option Key dialog box where you can enter an option key (alphanumeric string) to enable a software option. Refer to <i>Option Key Dialog Box</i> on page 3-24 for more information.
Status	Opens the Status dialog box where you can check general system information including the software and hardware versions. Refer to <i>Status Dialog Box</i> on page 3-25 for more information.

Communication Dialog Box. When you select the Communication command from the Utility menu, the Communication dialog box appears as shown in Figure 3-9.

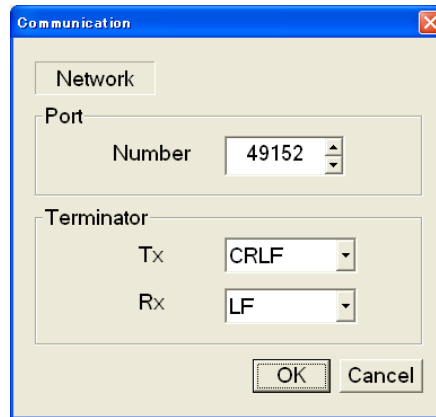

Figure 3-9: Communication dialog box

- **Port Number:** Sets the port number needed to remotely control the MTX100A over an Ethernet network. You can set the value from 1024 to 65535.

Press the **TAB** button repeatedly to select the box, and then press the up (▲) or down (▼) arrow button to set the value.

- **Terminator Tx:** Sets the terminator used when the MTX100A sends information to a controller. You can select LF (linefeed), CR (carriage return), CRLF (carriage return and linefeed), or LFCR (linefeed and carriage return).

Press the **TAB** button repeatedly to select the list box, and then press the arrow buttons to select one of the terminators.

- **Terminator Rx:** Sets the terminator used when the MTX100A receives commands from a controller. You can select LF (linefeed) or CR (carriage return).

Press the **TAB** button repeatedly to select the list box, and then press the arrow buttons to select one of the terminators.

Press the **ENTER** button to enable all setting changes.

Option Key Dialog Box. When you select the Option Key command from the Utility menu, the Option Key dialog box appears as shown in Figure 3-10.

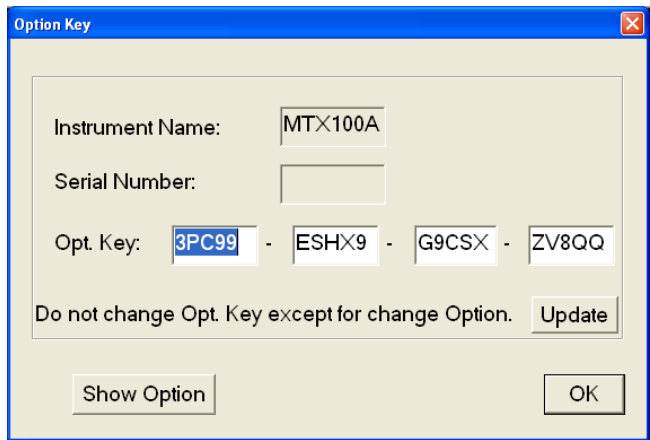

Figure 3-10: Option Key dialog box

- **Instrument Name:** Displays the instrument name.
- **Serial Number:** Displays the instrument serial number.
- **Opt. Key:** Enters an option key (alphanumeric string) that enables a software option. The option key is supplied as part of a software upgrade kit.



CAUTION. Do not change any alphanumeric characters previously installed in the entry fields except when you enter an option key. Doing so may cause the instrument to function improperly.

Refer to the documentation supplied with the software upgrade kit for detailed information on how to enable the purchased software option.

- **Update:** Enables the entered option key.
- **Show Option:** Displays the option(s) currently installed in the instrument.

Status Dialog Box. When you select the Status command from the Utility menu, the Status dialog box appears as shown in Figure 3-11.

This dialog box shows the version of the MTX100A application and hardware version of the main and installed interface modules.

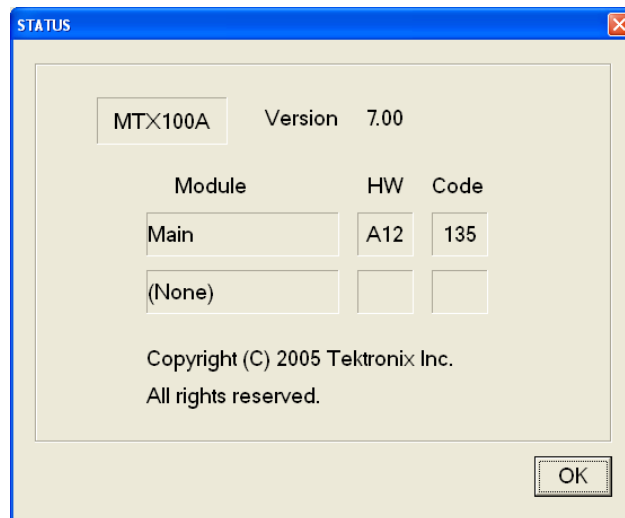

Figure 3-11: Status dialog box

Menus in the Record Screen

This subsection describes the menus available in the Record screen.

File Menu The File menu in the Record screen contains commands for setting the save mode and for saving and loading a preset file. This menu also contains commands for exiting the MTX100A application and for shutdown of the instrument. Table 3-9 describes the commands in the File menu.

Table 3-9: File menu commands (Record screen)

Command	Description
Save	Specifies the file name used when you save stream data. When you select this command, the Save as dialog box appears. By default, the current data (yymmdd) is used as a file name.
Save Mode	Sets the save mode when you save stream data. You can select Over Write or New File. In the Over Write mode, the existing file is overwritten by the new file with the name specified in the Save command whenever you save a stream data. In the New File mode, a new file is created whenever you save a stream file. The file name is the following: the name specified by the Save commands + # (1,2,3,4...).
Load Preset	Loads the specified preset file (*.set). When a preset file is loaded, the current instrument settings are changed by the file's content. Refer to <i>Preset File</i> beginning on page 3-63 for more information about the preset file.
Save Preset	Saves the current instrument settings as a preset file. Refer to <i>Preset File</i> beginning on page 3-63 for more information about the preset file.
PLAY	Switches to the Play screen.
Minimize	Minimizes the MTX100A application window.
Exit	Quits the MTX100A application. The MTX100A application settings are saved.
Shutdown	Quits the MTX100A application and shuts down the MTX100A.

View Menu The View menu contains commands that control the display of the Toolbar and Status bar. The View menu in the Record screen is the same as that in the Play screen. Refer to Table 3-2 on page 3-5 for the commands available in the View menu.

Record Menu The Record menu contains commands for setting the input interface, record size, trigger position, and target source. Table 3-10 describes the commands in the Record menu.

Table 3-10: Record menu commands

Command	Description
Source	Sets the interface used to input a stream data. You can select SPI (standard) or the name of the interface option currently installed (Univ I/F, ASI, ASI/1394, or ASI/310M). For SPI, the SPI In/Out connector is used.
Target	Opens the Target Dialog box where you can set the record size, trigger position, and target source to record the input stream. Refer to <i>Target Dialog Box</i> on page 3-27 for more information.
Timer Record	Opens the Timer Play/Record dialog box where you can set the time used to record the input stream automatically. Refer to <i>Timer Play/Record Dialog Box</i> on page 3-13 for more information.
Other	Opens the Others dialog box where you can set the standard used to display the input stream, display radix for the text information, and external trigger status. Refer to <i>Others Dialog Box</i> on page 3-29 for more information.

Target Dialog Box. When you select the Target command from the Record menu, the Target dialog box appears as shown in Figure 3-12.

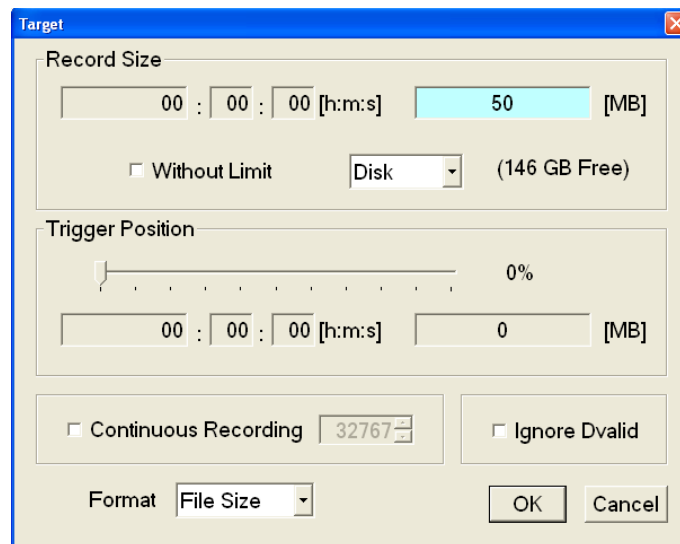

Figure 3-12: Target dialog box

- **Record Size:** Sets the recording time (h:m:s) or file size (MB) to record the input stream. Use the Format list box to select the way to set the record size.

Press the **TAB** button repeatedly to select the text box (or one of the text boxes for setting a time), and then press the **SELECT** button to open the keypad. Use the keypad to set the desired value.

The amount of free space available for the RAM or hard disk is displayed below the data size text box. You cannot set the record size beyond this value.

Use the **Without Limit** check box to record the input stream to the full free space in the hard disk or RAM. When it is checked, the available recording time and data size are automatically set. In addition, when the check box is enabled, the Continuous Recording check box becomes disabled.

NOTE. When you set the pretrigger portion, the same free space as the record size is required.

There is a list box in the Record Size field to select which record target (RAM or hard disk) is used to record the input stream. Press the **TAB** button repeatedly to select the list box, and press the arrow buttons to toggle between Disk or RAM.

- **Trigger Position:** Sets the trigger position used to record the input stream. You can set the trigger position by a time (h:m:s) or file size (MB).

Press the **TAB** button repeatedly to select the slider, and then press the left (◀) or right (▶) arrow button to move it to the desired position.

- **Continuous Recording:** Sets whether to enable Continuous Recording. With Continuous Recording, you can record multiple stream files continuously on the hard disk. Press the **TAB** button to select the check box, and then press the **SELECT** button to toggle the check box on (checked) or off (not checked).

When the check box is enabled, the spin box (at the right side of the check box) becomes available. Use the spin box to set the number of files after which to stop Continuous Recording. After the specified number of files are created, stream capture stops automatically. You can set the value from 2 to 32767.

When this option is selected, the Without Limit check box becomes disabled.

Refer to *Continuous Recording Feature* beginning on page 3-57 for detailed information about Continuous Recording.

- **Ignore D valid:** Sets whether the MTX100A ignores the DVALID signal from the selected interface when a stream data is acquired. When it is checked, the MTX100A ignores the DVALID signal, and the stream data is acquired according to the internal clock signal. This option is not available for the ASI interface option.

Press the **TAB** button to select the check box, and then press the **SELECT** button to toggle the check box on (checked) or off (not checked).

- **Format:** Specifies the way to set the record size and trigger position. You can select Time or File Size.

Press the **ENTER** button to enable all the settings and to close the dialog box.

Others Dialog Box. When you select the Other command from the Record menu, the Others dialog box appears as shown in Figure 3-13.

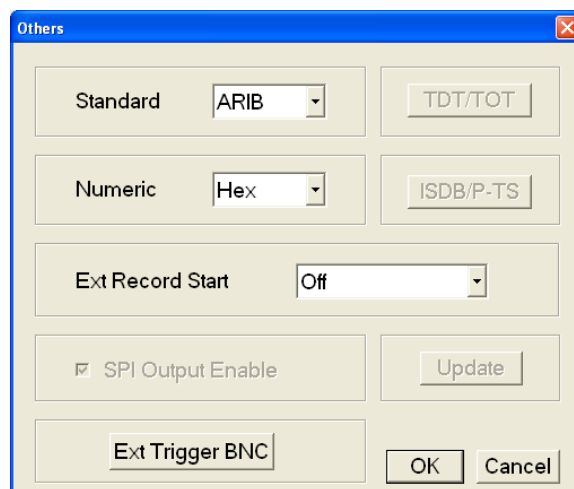

Figure 3-13: Others dialog box

- **Standard:** Sets the standard used to display the input stream. You can select ARIB, ATSC, DVB, or MPEG2.

Press the **TAB** button repeatedly to select the list box, and then press the arrow buttons to select one of the standards.

- **Numeric:** Sets the base value used to describe the component information in the hierarchy display. You can select Decimal, Hex, or Octal.

Press the **TAB** button repeatedly to select the list box, then press the arrow buttons to select one of the base values.

- **Ext Record Start:** Sets whether or not to start input stream record using a trigger signal applied to the Trig In/Out connector. You can select Off, Rise, or Fall. When you select Rise, the input stream record is started at the rising edge of the applied trigger signal. When you select Fall, the input stream record is started at the falling edge of the applied trigger signal.

When you use the external trigger signal to record the input stream, if the pretrigger portion is defined, the MTX100A acquires pretrigger data when a valid trigger signal occurs and then waits for a trigger. When a valid trigger signal occurs again, the MTX100A acquires posttrigger data and then creates a stream file.

Press the **TAB** button repeatedly to select the list box, and then press the arrow buttons to select one of the external record modes.

- **Ext Trigger BNC:** This item is common to the Play screen. Refer to *Ext Trigger BNC* on page 3-15 for detailed information.

Press the **ENTER** button to enable all setting changes.

ASI I/F Menu (Option 01 Only)

The ASI I/F menu is displayed when the ASI interface option is installed. This menu contains command for setting the input status. Table 3-11 describes the command available in the ASI I/F menu.

Table 3-11: ASI I/F menu command (Record screen)

Command	Description
Through Out	Sets whether the signal applied to the ASI IN connector is output from the ASI Out connector when a stream is not output. You can select On or Off.

Univ I/F Menu (Option 02 Only)

The Univ I/F menu is displayed when the universal parallel/serial interface option is installed. This menu contains commands for setting the input status such as output signal level, output format, and polarity of the EVENT signal. Table 3-12 describes the commands available in the Univ I/F menu.

Table 3-12: Univ I/F menu commands (Record screen)

Command	Description
Level	Sets the signal level applied to the Universal In/Out connector. You can select TTL, ECL, or LVDS. Refer to <i>Appendix A: Specifications</i> for more detailed electrical characteristics.
Format	Sets the signal format applied to the Universal In/Out connector. You can select Parallel or Serial.
Clock	Sets the polarity of the input clock signal. You can select Rise or Fall.
Use Psync	Sets whether the PSYNC signal is used for serial input. You can select On or Off. When you select to On, the MSB is determined from the PSYNC signal. When you select to Off, the MSB is determined from the bit pattern of the sync byte.
Receive	Sets the input mode for the parallel interface. You can select Differential or Single End.

Table 3-12: Univ I/F menu commands (Record screen) (cont.)

Command	Description
Termination	Sets the internal termination either On or Off. When you have selected Single End from the Receive command, you cannot select Off.

ASI/1394 Menu (Option 05 Only)

The ASI/1394 menu is displayed when the IEEE1394/ASI interface option is installed. This menu contains commands for selecting the connector used to capture a stream and setting the operation mode for the IEEE1394 interface. Table 3-13 describes the commands available in the ASI/1394 menu.

Table 3-13: ASI/1394 menu commands (Record screen)

Command	Description
Input Port	Sets the connector used to capture a stream. You can select ASI (ASI Input connector) or 1394 (IEEE1394 connector).
Partial TS	<p>Sets whether the input transport stream from the IEEE1394 connector is recorded in the partial transport stream (TS) format. You can select On or Off. When you record a partial transport stream, be sure to set this command to On.</p> <p>NOTE: When this command is set to On, you cannot capture a transport stream of the packet size other than 188 bytes. The No Signal message appears on the Record screen.</p> <p>Refer to <i>About the Partial Transport Stream</i> on page 3-131 for more information.</p>
1394 Mode	<p>Sets the connection mode when using the IEEE1394 interface. You can select PtoP Connect (point-to-point connection) or Probe (data probing).</p> <p>In the PtoP Connect mode, you can connect the MTX100A Option 05 and an IEEE1394 device using a point-to-point line configuration. In the Probe mode, when the connection between two IEEE1394 devices is established, you can capture the transport stream transmitting between them by the MTX100A Option 05.</p> <p>When you select these modes, the IEEE1394 dialog box appears. Refer to <i>IEEE1394 Dialog Box</i> on page 3-21 for more information.</p>
Bus Reset	<p>Resets the IEEE1394 bus. Use this command to reset the connection when the MTX100A Option 05 does not recognize the IEEE1394 device or when the IEEE1394 device does not recognize the MTX100A Option 05.</p> <p>NOTE: If you reset the IEEE1394 bus while the MTX100A Option 05 sends or receives data, the operation is stopped. In addition, the IEEE1394 connection is terminated.</p>

IEEE1394 Dialog Box. When you select PtoP Connect or Probe from the 1394 Mode command in the ASI/1394 menu, the IEEE1394 dialog box appears as shown in Figure 3-14.

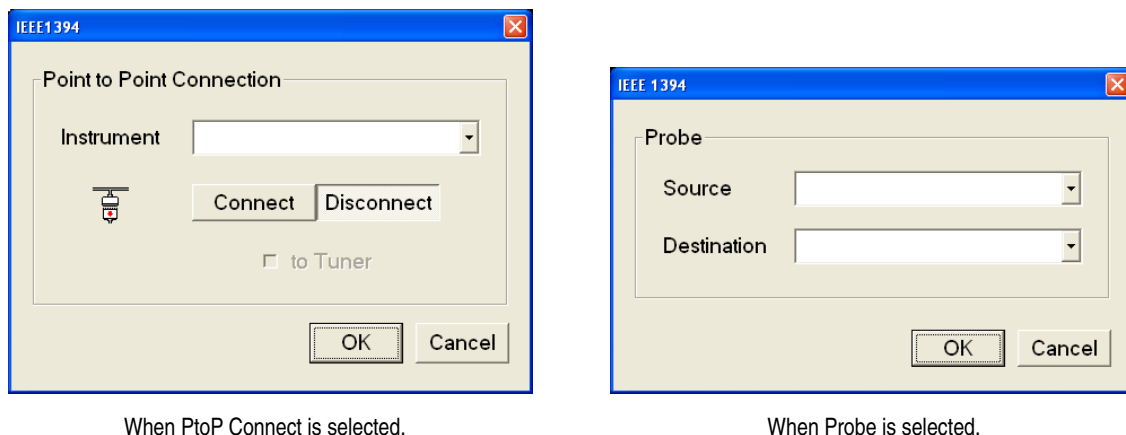

When PtoP Connect is selected.

When Probe is selected.

Figure 3-14: IEEE1394 dialog box (Record screen)

■ **When PtoP Connect is selected:**

- **Instrument:** Selects the IEEE1394 device for the point-to-point connection.

Press the **TAB** button repeatedly to select the list box, and then press the arrow buttons to select the instrument.

- **Connect or Disconnect:** Connects or disconnects the selected IEEE1394 device.

NOTE. *If bus reset occurs by disconnecting an IEEE1394 cable when the point-to-point connection is established, the connection is terminated.*

- **to Tuner:** Sets whether the connection setting is made by the IEEE1394 device in connecting the MTX100A Option 05 and an IEEE1394 device.

Press the **TAB** button repeatedly to select the check box, and then press the **SELECT** button to toggle the check box on (checked) or off (not checked).

Some IEEE1394 devices do not recognize the MTX100A Option 05 when you make a connection from the MTX100A Option 05. In this case, when you select this check box, the IEEE1394 device takes the initiative for the connection. You need to select the check box when you connect a BS/CS tuner to the MTX100A Option 05.

Press the **ENTER** button on the front panel to enable all the settings and to close the dialog box.

■ **When Probe is selected:**

- **Source:** Select the IEEE1394 device for the source.

Press the **TAB** button repeatedly to select the list box, and then press the arrow buttons to select the instrument.

- **Destination:** Select the IEEE1394 device for the destination.

Press the **TAB** button repeatedly to select the list box, and then press the arrow buttons to select the instrument.

Press the **ENTER** button on the front panel to enable all the settings and to close the dialog box.

Refer to *Using the IEEE1394 Interface (Option 05 only)* on page 3-125 for detailed information on how to connect the MTX100A Option 05 and an IEEE1394 device(s), and how to set up the MTX100A Option 05 when using the PtoP Connect and Probe modes.

310M/ASI/SPI Menu (Option 07 Only)

The 310M/ASI/SPI menu is displayed when the SMPTE310M/ASI/SPI interface option is installed. This menu contains a command for selecting the connector used to capture a stream and setting a signal format applied to the BNC connector. Table 3-14 describes the command available in the 310M/ASI/SPI menu.

Table 3-14: 310M/ASI/SPI menu command (Record screen)

Command	Description
Input Port	Sets the connector used to capture a stream. You can select BNC (SMPTE310M/ASI Input connector) or SPI (SPI Input connector). You can select BNC or SPI.
BNC Port	Sets the signal format applied to the SMPTE310M/ASI Input connector. You can select ASI or 310M 8VSB (SMPTE310M signal with data rate of 8VSB).
Time Stamp	Sets whether or not the time stamp function is enabled. You can select On or Off. If you select On, packet arrival time information is stored in each packet in a transport stream. In this feature, 8-byte data including 5-byte time stamp are added at the end of each 204-byte packet in a transport stream. For 188-byte packet data, each packet size is increased to 204 bytes to accommodate the time stamp data. For 204-byte packet data, the last eight bytes are overwritten with the 8-byte data.

Utility Menu

The Utility menu contains commands for displaying the system information such as software and hardware versions. The Utility menu in the Record screen is the same as that of the Play screen. Refer to Table 3-8 on page 3-22 for detailed information.

Toolbar Buttons

The toolbar provides shortcut buttons for many of the most often used menu commands. Click the appropriate button to implement one of the functions described in Table 3-15.

NOTE. To access the toolbar buttons, you need to connect a USB mouse to the USB connector on the front panel.

Table 3-15: Toolbar button descriptions













Icon	Name	Function
	LOAD TS file	Opens the Select File dialog box. Equivalent to the Open command in the File menu. This button is available when the Play screen is displayed.
	SAVE TS file	Opens the Save as dialog box. Equivalent to the Save command in the File menu. This button is available when the Record screen is displayed.
	Load Preset	Opens the Open dialog box. Equivalent to the Load Preset command in the File menu.
	Save Preset	Opens the Save as dialog box. Equivalent to the Save Preset command in the File menu.
	Play	Outputs the selected stream. Equivalent to the PLAY button on the front panel.
	Record	Records the acquired stream. Equivalent to the RECORD button on the front panel.
	Stop	Stops the stream output or stream record. Equivalent to the STOP button on the front panel.
	Clock	Opens the Clock dialog box. Equivalent to the Clock command in the Play menu. This button is available when the Play screen is displayed.
	Target	Opens the Target dialog box. Equivalent to the Target command in the Record menu. This button is available when the Record screen is displayed.

Table 3-15: Toolbar button descriptions (cont.)

Icon	Name	Function
Toolbar buttons only available for Option 05		
	Connect	Starts the connection to an IEEE1394 device. Equivalent to the Connect button in the IEEE1394 dialog box.
	PtoP Connect	Opens the IEEE1394 dialog box for a point-to-point connection. Equivalent to the PtoP Connect item from the 1394 Mode command in the ASI/1394 menu.
	Probe	Opens the IEEE1394 dialog box for data probing. Equivalent to the Probe item from the 1394 command in the ASI/1394 menu. This button is available when the Record screen is displayed.

Hierarchy Display

The MTX100A displays the selected transport stream using a hierarchy structure. This section describes the hierarchy display and defines each icon you may encounter in the display.

Overview of the Hierarchy Display

The MTX100A uses icons displayed in a hierarchical structure to show the interrelationship of transport stream components (see Figure 3-15). Additional information about each stream component such as PID and Table ID numbers is displayed next to each icon.

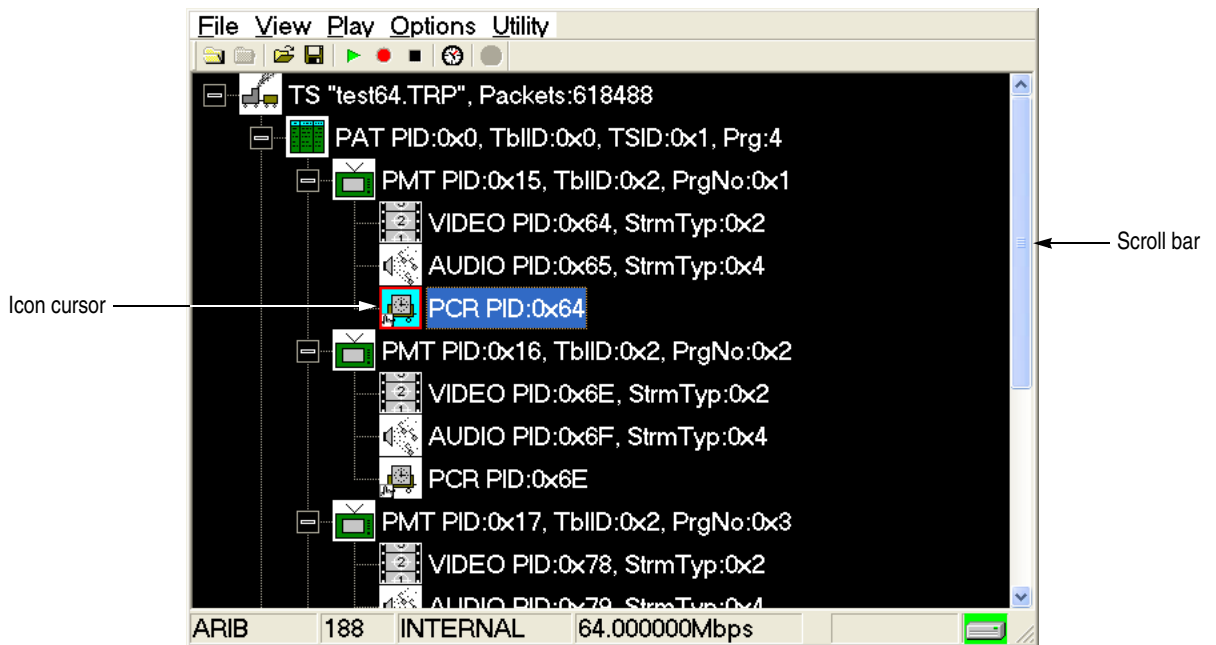

Figure 3-15: Example of the hierarchy display

The “+” symbol displayed to the left of some icons indicates that the item includes lower-level transport stream components that are not displayed. The symbol changes to “-” when the lower level components are displayed. To expand the hierarchy, select the desired upper-level icon and press the right control button, and to collapse the selected upper-level icon press the left control button.

When a transport stream contains more items than will display on the screen at one time, a scroll bar appears at the right of the screen.

The Icon cursor is used to select individual transport stream components as represented by the icons. The Icon cursor is displayed as a red square (border) surrounding a hierarchy icon (see Figure 3-15). Use the arrow buttons to move the Icon cursor through the hierarchy. The hierarchy display scrolls (if applicable) when the Icon cursor reaches the top or bottom of the displayed portion of the hierarchy.

When the menus are enabled, the Icon cursor is disabled. Press the front-panel MENU button to toggle control between the Icon cursor and the menus.

Hierarchy Display Icons

Table 3-16 describes the icons you may encounter in the hierarchy display of the MTX100A for transport streams using the MPEG-2, ARIB, DVB, and ATSC formats.

Table 3-17 on page 3-41 describes icons that are specific to transport streams using DVB format.

Table 3-18 on page 3-42 describes icons that are specific to transport streams using ARIB format.

Table 3-19 on page 3-44 describes icons that are specific to transport streams using the ATSC format.

Refer to *Icon Text and Dialog Box* on page 3-45 for descriptions of the icon text and dialog box associated with the hierarchy icon.

Table 3-16: Icons used for MPEG-2, ARIB, DVB, and ATSC formats



Icon	Element type
	ISDB-T Broadcast transport stream that is defined ARIB STD-B31.
	S-TMCC Transport stream to which TMCC information is inserted into 8 bytes in its Reed-Solomon area (16 bytes).
	M-TMCC Transport stream to which TMCC information is inserted into its sync byte area, and having super frame structure.
	Non TS Data stream other than transport stream format.

Table 3-16: Icons used for MPEG-2, ARIB, DVB, and ATSC formats (cont.)













Icon	Element type
	<p>Transport Stream (TS)</p> <p>This icon represents all transport stream packets that make up the stream.</p>
	<p>Program Association Table (PAT)</p> <p>One or more transport packets with a PID value and table_id value of 0x00.</p>
	<p>Transport Stream Description Table (TSDT)</p> <p>One or more transport packets with a PID value of 0x02 and a table_id value of 0x03.</p>
	<p>Network Information Table (NIT)</p> <p>One or more transport packets with a PID value specified by the network_PID in the PAT.</p>
	<p>Conditional Access Table (CAT)</p> <p>One or more transport packets with a PID value of 0x01 and a table_id value of 0x0001.</p>
	<p>Program Map Table (PMT)</p> <p>One or more transport packets with a PID value specified by the program_map_PID in the PAT and a table_id value of 0x02.</p>
	<p>Program Clock Reference (PCR)</p> <p>One or more transport packets with a PID value specified by the PCR_PID in the PMT and a PCR_flag value of 1.</p>
	<p>Video elementary stream</p> <p>One or more transport packets with a PID value specified by the elementary_PID in the PMT and a stream_type value of 0x01, 0x02, or 0x10.</p>
	<p>A lock symbol appears in the icon when the transport_scrambling_control value is set to 01.</p>
	<p>Audio elementary stream</p> <p>One or more transport packets with a PID value specified by the elementary_PID in the PMT and a stream_type value of 0x03, 0x04, or 0x11.</p>
	<p>A lock symbol appears in the icon when the transport_scrambling_control value is set to 01.</p>
	<p>Audio AAC, Audio AC3 (ATSC format)</p> <p>One or more transport packets with a PID value specified by the elementary_PID in the PMT and a stream_type value of 0x0F or 0x81 (ATSC format).</p>
	<p>A lock symbol appears in the icon when the transport_scrambling_control value is set to 01.</p>

Table 3-16: Icons used for MPEG-2, ARIB, DVB, and ATSC formats (cont.)









Icon	Element type
	<p>Data stream</p> <p>One or more transport packets with a PID value specified by the elementary_PID in the PMT and a stream_type value of other than 0x01-0x05, 0x08, and 0x0F (in ATSC format, 0x81).</p> <p>A lock symbol appears in the icon when the transport_scrambling_control value is set to 01.</p>
	<p>Private Section</p> <p>One or more transport packets with a PID value specified by the elementary_PID in the PMT and a stream_type value of 0x05.</p> <p>A lock symbol appears in the icon when the transport_scrambling_control value is set to 01.</p>
	<p>Digital Storage Media Command and Control (DSM-CC)</p> <p>One or more transport packets with a PID value specified by the elementary_PID in the PMT and a stream_type value of 0x08.</p> <p>A lock symbol appears in the icon when the transport_scrambling_control value is set to 01.</p>
	<p>Entitlement Control Message (ECM)</p> <p>One or more transport packets with a PID value specified by the CA_PID of the CA_descriptor in the PMT, a payload_start_unit_indicator value of 1, and the payload does not start 000001 (section) or the payload starts 000001 (PES).</p>
	<p>Entitlement Management Message (EMM)</p> <p>One or more transport packets with a PID value specified by the CA_PID of the CA_descriptor in the CAT, a payload_start_unit_indicator value of 1, and the payload does not start 000001 (section) or the payload starts 000001 (PES).</p>
	<p>GHOST</p> <p>One or more transport packets with a PID value not specified in the PSI or Private Section PID file when the transport stream is downloaded.</p>
	<p>NULL</p> <p>One or more transport packets with a PID value of 0x1FFF.</p>
	<p>GARBAGE</p> <p>One or more transport packets in the section-data structure at the beginning of the section are not complete.</p>
	<p>Adaptation Field Error (ADFERR)</p> <p>One or more transport packets with an adaptation_field_control value of 0x00.</p>

Table 3-17: Icons specific to DVB format



Icon	Element type	
	Service Description Table (SDT) One or more transport packets with a PID value of 0x0011 and a table_id value of 0x42.	
	Bouquet Association Table (BAT) One or more transport packets with a PID value of 0x0011 and a table_id value of 0x4A.	
	Event Information Table (EIT) One or more transport packets with a PID value of 0x0012 and a table_id value of 0x4E-0x6F.	
	Running Status Table (RST) One or more transport packets with a PID value of 0x0013 and a table_id value of 0x4E-0x71.	
	Stuffing Table (ST) One or more transport packets with a PID value of 0x0010-0x0013 and a table_id value of 0x72.	
	Discontinuity Information Table (DIT) One or more transport packets with a PID value of 0x1E and a table_id value of 0x7E.	
	Selection Information Table (SIT) One or more transport packets with a PID value of 0x1F and a table_id value of 0x7F.	
		Time and Data Table (TDT) One or more transport packets with a PID value of 0x0014 and a table_id value of 0x72.
		Time Offset Table (TOT) One or more transport packets with a PID value of 0x0014 and a table_id value of 0x73.

Table 3-18: Icons specific to ARIB format



Icon	Element type
	<p>Service Description Table (SDT)</p> <p>One or more transport packets with a PID value of 0x0011 and a table_id value of 0x42.</p>
	<p>Bouquet Association Table (BAT)</p> <p>One or more transport packets with a PID value of 0x0011 and a table_id value of 0x4A.</p>
	<p>Event Information Table (EIT)</p> <p>One or more transport packets with a PID value of 0x0012 and a table_id value of 0x4E-0x6F.</p>
	<p>Running Status Table (RST)</p> <p>One or more transport packets with a PID value of 0x0013 and a table_id value of 0x4E-0x71.</p>
	<p>Stuffing Table (ST)</p> <p>One or more transport packets with a PID value of 0x0010-0x0013 and a table_id value of 0x72.</p>
	<p>Discontinuity Information Table (DIT)</p> <p>One or more transport packets with a PID value of 0x1E and a table_id value of 0x7E.</p>
	<p>Selection Information Table (SIT)</p> <p>One or more transport packets with a PID value of 0x1F and a table_id value of 0x7F.</p>
	<p>Local event Information Table (LIT)</p> <p>One or more transport packets with a PID value of 0x0020 and a table_id value of 0xD0.</p>
	<p>One or more transport packets with a PID value specified by the elementary_PID in the PMT and a table_id value of 0xD0 when a stream type value is 0x05.</p>
	<p>Event Relation Table (ERT)</p> <p>One or more transport packets with a PID value of 0x0021 and a table_id value of 0xD1.</p>
	<p>One or more transport packets with a PID value specified by the elementary_PID in the PMT and a table_id value of 0xD1 when a stream type value is 0x05.</p>
	<p>Index Transmission Table (ITT)</p> <p>One or more transport packets with a PID value specified by the elementary_PID in the PMT and a table_id value of 0xD2.</p>
	<p>Partial Content Announcement Table (PCAT)</p> <p>One or more transport packets with a PID value of 0x22 and a table_id value of 0xC2.</p>

Table 3-18: Icons specific to ARIB format (cont.)



Icon	Element type
	<p>Software Download Trigger Table (SDTT)</p> <p>One or more transport packets with a PID value of 0x23 and a table_id value of 0xC3.</p>
	<p>Download Control Table (DCT)</p> <p>One or more transport packets with a PID value of 0x17 and a table_id value of 0xC0.</p>
	<p>DownLoad Table (DLT)</p> <p>One or more transport packets with a PID value specified by the DL_PID in the DCT and a stream_type value of 0xC1.</p> <p>A lock symbol appears in the icon when the transport_scrambling_control value is set to 01.</p>
	<p>Broadcaster Information Table (BIT)</p> <p>One or more transport packets with a PID value of 0x24 and a table_id value of 0xC4.</p>
	<p>Network Board Information Table (NBIT)</p> <p>One or more transport packets with a PID value of 0x25 and a table_id value of 0xC5 or 0xC6.</p>
	<p>Linked Description Table (LDT)</p> <p>One or more transport packets with a PID value of 0x25 and a table_id value of 0xC7.</p>
	<p>Time and Data Table (TDT)</p> <p>One or more transport packets with a PID value of 0x0014 and a table_id value of 0x72.</p>
	<p>Time Offset Table (TOT)</p> <p>One or more transport packets with a PID value of 0x0014 and a table_id value of 0x73.</p>

Table 3-19: Icons specific to ATSC format

Icon	Element type	
	<p>Master Guide Table (MGT)</p> <p>One or more transport packets with a PID value of 0x1FFB and a table_id value of 0xC7.</p>	
	<p>Terrestrial Virtual Channel Table (TVCT)</p> <p>One or more transport packets with a PID value of 0x1FFB and a table_id value of 0xC8.</p>	
	<p>Cable Virtual Channel Table (CVCT)</p> <p>One or more transport packets with a PID value of 0x1FFB and a table_id value of 0xC9.</p>	
	<p>Rating Region Table (RRT)</p> <p>One or more transport packets with a PID value of 0x1FFB and a table_id value of 0xCA.</p>	
	<p>Event Information Table (EIT)</p> <p>One or more transport packets with a PID value specified by the table_type_PID in the MGT and a table_id value of 0xCB.</p>	
	<p>Channel Extended Text Table (CETT)</p> <p>One or more transport packets with a PID value of 0x1FFB and a table_id value of 0xC8.</p>	
	<p>Event Extended Text Table (EETT)</p> <p>One or more transport packets with a PID value of 0x1FFB and a table_id value of 0xC9.</p>	
	<p>Program Identifier Table (PIT)</p> <p>One or more transport packets with a PID value specified by the elementary_PID in the PMT and a table_id value of 0xD0 when a stream_type value is 0x85.</p>	
		<p>System Time Table (STT)</p> <p>One or more transport packets with a PID value of 0x1FFB and a table_id value of 0xCD.</p>

Icon Text and Dialog Box

To the right of each icon, the MTX100A displays text that describes each transport stream component. In addition, for the PCR icon, you can display a dialog box to change the parameters for the component.

This subsection describes the text information for each icon type and the dialog box available for the PCR icon.

- ISDB-T Icon** The following text information is displayed for the ISDB-T icon:
- “xxx.rmx”: Shows the file name.
 - Packets: Shows the total number of packets in the broadcast transport stream.
- S-TMCC Icon** The following text information is displayed for the S-TMCC icon:
- “xxx.trp”: Shows the file name.
 - TC8PSK/xx, BPSK/xx, or QPSK/xx: Shows the modulation system and the number of contract slots (xx).
- M-TMCC Icon** The following text information is displayed for the M-TMCC icon:
- “xxx.trp”: Shows the file name.
 - SF: Shows the number of super frames.
- Non TS Icon** The following text information is displayed for the Non Transport Stream (Non TS) icon:
- “xxx.xx”: Shows the file name.
 - FileSize: Shows the file size in byte.

Transport Stream (TS) Icon The following text information is displayed for the Transport Stream (TS) icon:

- “xxx.trp”: Shows the file name of the transport stream.
- Packets: Shows the total number of packets in the transport stream.

When this icon is used with the S-TMCC or M-TMCC icon, the following text information is displayed.

- TSID: Shows the ID number for the transport stream.
- TC8PSK/xx, BPSK/xx, or QPSK/xx: Shows the modulation system and the number of contract slots (xx).

Program Association Table (PAT) Icon The following text information is displayed for the Program Association Table (PAT) icon:

- PID: Shows the PID value of the PAT.
- TblID: Shows the table_id value of the PAT.
- TSID: Shows the transport_stream_id value of the PAT.
- Prg: Shows the number of programs contained in the transport stream.

Transport Stream Description Table (TSDT) Icon The following text information is displayed for the Transport Stream Description Table (TSDT) icon:

- PID: Shows the PID value of the TSDT.
- TblID: Shows the table_id value of the TSDT.

Network Information Table (NIT) Icon The following text information is displayed for the Network Information Table (NIT) icon:

- PID: Shows the PID value of the NIT.
- TblID: Shows the table_id value of the NIT.

Conditional Access Table (CAT) Icon The following text information is displayed for the Conditional Access Table (CAT) icon:

- PID: Shows the PID value of the CAT.
- TblID: Shows the table_id value of the CAT.

Program Map Table (PMT) Icon

The following text information is displayed for the Program Map Table (PMT) icon:

- PID: Shows the PID value of the PMT.
- TblID: Shows the table_id value of the PMT.
- PrgNo: Shows the program number associated with the PMT.

Program Clock Reference (PCR) Icon

The following text information is displayed for the Program Clock Reference (PCR) icon:

- PID: Shows the PID value of the PCR.

PCR Inaccuracy Dialog Box. If you press the SELECT button when the PCR icon is selected, the PCR Inaccuracy dialog box appears as shown in Figure 3-16. This dialog box allows you to add jitter to the program_clock_reference_base value and the program_clock_reference_extension value.

Refer to *Adding Jitter to PCRs* on page 3-53 for more information.

Table 3-20 describes the PCR Inaccuracy dialog box parameters.

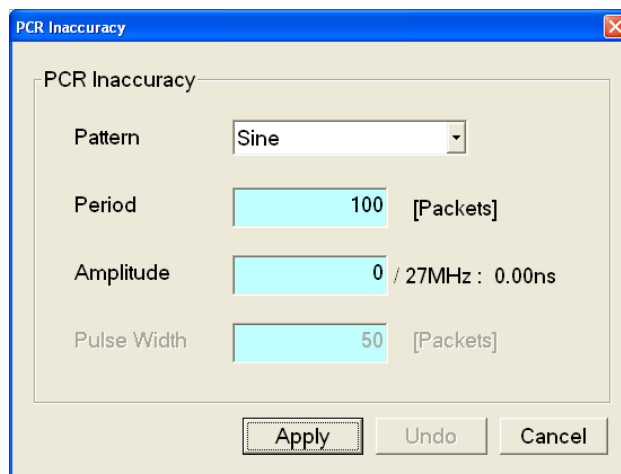

Figure 3-16: PCR Inaccuracy dialog box

Table 3-20: PCR Inaccuracy dialog box parameters

Parameter	Description
Pattern	Selects the waveform type of the waveform used to add jitter. You can select Sine, Square, Triangle, Pulse, Sawtooth, Random, or Offset.
Period	Sets the period of the waveform used to add jitter. You can set the value from 5 to 3000 packets in 1 packet steps.
Amplitude	Sets the amplitude of the waveform used to add jitter. You can set the value from 0/27 MHz to 135000000/27 MHz (0 s to 5 s).
Pulse Width	Sets the pulse width of the waveform used to add jitter. You can set the value from 1 to (period - 1) packet(s) in 1 packet steps. This Pulse Width parameter is available only when the Pattern parameter is set to Pulse.

Video Elementary Stream (VIDEO) Icon

The following text information is displayed for the video elementary stream (VIDEO) icon:

- PID: Shows the PID value of the video elementary stream.
- StrmTyp: Shows the type of the video elementary stream (0x01 or 0x02).

Audio Elementary Stream (AUDIO) Icon

The following text information is displayed for the audio elementary stream (AUDIO) icon:

- PID: Shows the PID value of the audio elementary stream.
- StrmTyp: Shows the type of the audio elementary stream (0X03 or 0X04).

AUDIO_AAC and AUDIO_AC3 Icons

The following text information is displayed for the AUDIO_AAC and ADIO_AC3 (ATSC only) icons:

- PID: Shows the PID value of the audio elementary stream.
- StrmTyp: Shows the type of the audio elementary stream (0X0F or 0x81).

Data Stream (DATA) Icon

The following text information is displayed for the data stream (DATA) icon:

- PID: Shows the PID value of the data stream.
- StrmTyp: Shows the type of the data stream.

Private Section (DATA_SECT) Icon	<p>The following text information is displayed for the private section (DATA_SECT) icon:</p> <ul style="list-style-type: none">■ PID: Shows the PID value of the private section.■ TblID: Shows the table_id value of the private section.■ StrmTyp: Shows the type of the private section.
DSM_CC Icon	<p>The following text information is displayed for the digital storage media command and control (DSM_CC) icon:</p> <ul style="list-style-type: none">■ PID: Shows the PID value of the data DSM-CC.■ StrmTyp: Shows the type of the DSM-CC.
Entitlement Control Message (ECM) Icon	<p>The following text information is displayed for the Entitlement Control Message (ECM) icon:</p> <ul style="list-style-type: none">■ PID: Shows the PID value of the ECM.■ TblID: Shows the table_id value of the ECM.
Entitlement Management Message (EMM) Icon	<p>The following text information is displayed for the Entitlement Management Message (EMM) icon:</p> <ul style="list-style-type: none">■ PID: Shows the PID value of the EMM.■ TblID: Shows the table_id value of the EMM.
GHOST Icon	<p>The following text information is displayed for the GHOST icon:</p> <ul style="list-style-type: none">■ PID: Shows the PID value of the GHOST.
Adaptation Field Error (ADFERR) Icon	<p>The following text information is displayed for the Adaptation Field Error (ADFERR) icon:</p> <ul style="list-style-type: none">■ PID: Shows the PID value of the ADFERR.
NULL Icon	<p>The following text information is displayed for the NULL icon:</p> <ul style="list-style-type: none">■ PID: Shows the PID value of the NULL.

GARBAGE Icon

The following text information is displayed for the GARBAGE icon:

- PID: Shows the PID value of the GARBAGE.

**SDT, BAT, EIT, RST, ST,
DIT, SIT, LIT, ERT, ITT,
PCAT, SDTT, DCT, DLT,
BIT, NBIT, and LDT Icons**

The following text information is displayed for the Service Description Table (SDT), Bouquet Association Table (BAT), Event Information Table (EIT), Running Status Table (RST), Stuffing Table (ST), Discontinuity Information Table (DIT), Selection Information Table (SIT), Local event Information Table (LIT), Event Relation Table (ERT), Index Transmission Table (ITT), Partial Content Announcement Table (PCAT), Software Download Trigger Table (SDTT), Download Control Table (DCT), DownLoad Table (DLT), Broadcaster Information Table (BIT), Network Board Information Table (NBIT), and Linked Description Table (LDT) icons:

- PID: Shows the PID value of the SDT, BAT, EIT, RST, ST, DIT, SIT, LIT, ERT, ITT, PCAT, SDTT, DCT, DLT, BIT, NBIT, or LDT.
- TblID: Shows the table_id value of the SDT, BAT, EIT, RST, ST, DIT, SIT, LIT, ERT, ITT, PCAT, SDTT, DCT, DLT, BIT, NBIT, or LDT.

TDT and TOT Icon

The following text information is displayed for the Time and Data Table (TDT) and Time Offset Table (TOT) icons:

- PID: Shows the PID value of the TDT or TOT.
- TblID: Shows the table_id value of the TDT or TOT.

MGT and PIT Icons

The following text information is displayed for the Master Guide Table (MGT) and Program Identifier Table (PIT) icons:

- PID: Shows the PID value of the MGT or PIT.
- TblID: Shows the table_id value of the MGT or PIT.

**TVCT, CVCT, RRT, EIT,
CETT, and EETT Icons**

The following text information is displayed for the Terrestrial Virtual Channel Table (TVCT), Cable Virtual Channel Table (CVCT), Rating Region Table (RRT), Event Information Table (EIT), Channel Extended Text Table (CETT), and Event Extended Text Table (EETT) icons:

- PID: Shows the PID value of the TVCT, CVCT, RRT, EIT, CETT, or EETT.
- TblID: Shows the table_id value of the TVCT, CVCT, RRT, EIT, CETT, or EETT.
- TblType: Shows the table_type value of the TVCT, CVCT, RRT, EIT, CETT, or EETT.

**System Time Table (STT)
Icon**

The following text information is displayed for the System Time Table (STT) icon:

- PID: Shows the PID value of the STT.
- TblID: Shows the table_id value of the STT.

Adding Jitter to PCRs

The MTX100A provides the capability to add jitter to PCRs (Program Clock References). Adding jitter to PCRs allows you to simulate transmission delay variations and to test the robustness of decoders under various conditions.

The jitter function adds jitter to the `program_clock_reference_base` value and the `program_clock_reference_extension` value in the adaptation field of transport stream packets. You can use this function to modulate the data values of the PCRs away from their correct values.

Adding Jitter

Perform the following procedure to add jitter to PCRs:

1. Use the Icon cursor to select the PCR item in the hierarchy display. If the Icon cursor is not available, press the **MENU** button to enable the Icon cursor.
2. Press the **SELECT** button. This opens the **PCR Inaccuracy** dialog box shown in Figure 3-17.

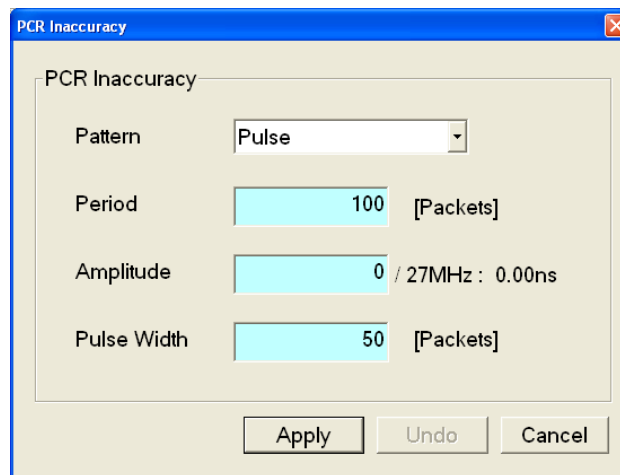

Figure 3-17: PCR Inaccuracy dialog box

3. The PCR Inaccuracy dialog box lets you set the parameters for how jitter will be added to the PCR.

- **Pattern:** Selects the type of waveform used to add jitter. You can select Sine, Square, Triangle, Pulse, Sawtooth, Random, or Offset.

Press the **TAB** button repeatedly to select the list box, and then press the arrow buttons to select the desired waveform.

- **Period:** Sets the period of the waveform used to add jitter. You can set the value from 5 to 3000 packets in 1 packet steps.

Press the **TAB** button repeatedly to select the text box, and then press the **SELECT** button to open the keypad. Use the keypad to enter the desired value.

- **Amplitude:** Sets the amplitude of the waveform used to add jitter. You can set the value from 0/27 MHz to 135000000/27 MHz (0 to 5 s).

Press the **TAB** button repeatedly to select the text box, and then press the **SELECT** button to open the keypad. Use the keypad to enter the desired value.

- **Pulse Width:** Sets the pulse width of the waveform used to add jitter. You can set the value from 1 to (period-1) packet(s) in 1 packet steps. This Pulse Width parameter is available only when the Pattern parameter is set to Pulse.

Press the **TAB** button repeatedly to select the text box, and then press the **SELECT** button to open the keypad. Use the keypad to enter the desired value.

4. After you have set the parameters, press the **ENTER** button to enable the jitter function.

Figure 3-18 shows the relationship among the parameters and how the PCR values (program_clock_reference_base value and program_clock_reference_extension) change when Sine is selected as a jitter-pattern waveform. The PCR values varies by the value of sine waveform defined by the amplitude and period. The PCR period does not change.

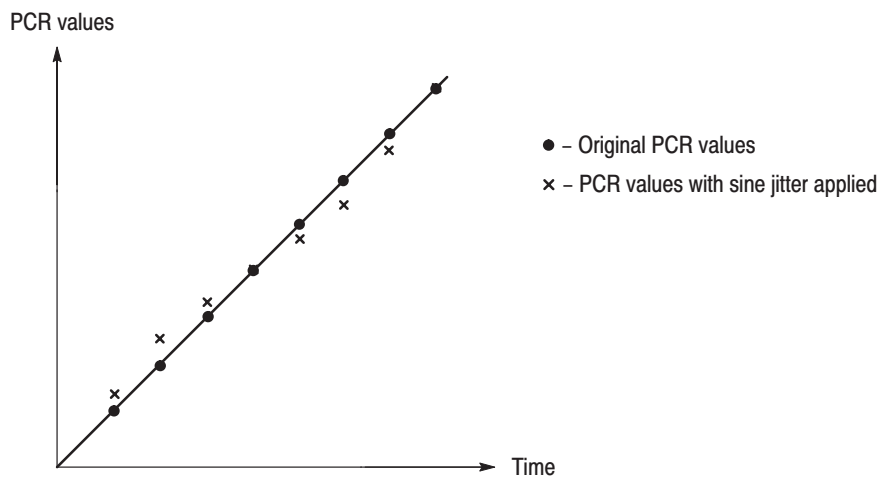
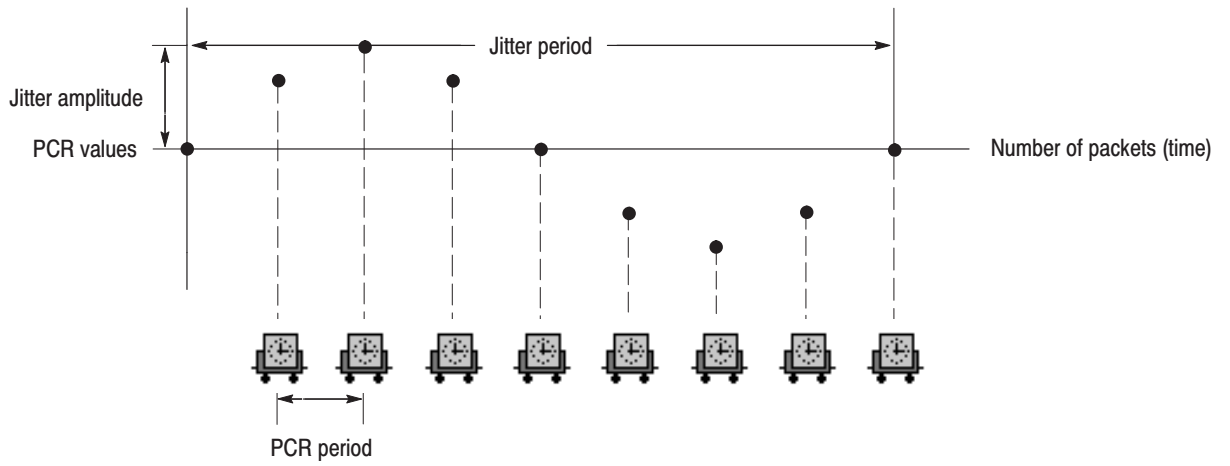

Figure 3-18: Jitter function with a sine jitter pattern applied

Continuous Recording Feature

The Continuous Recording feature allows you to record multiple stream files continuously on the hard disk or RAM.

This section describes features and basic action of Continuous Recording, and how to perform it to record stream files.

Overview

Continuous Recording has the following features:

- Record multiple stream files continuously on the hard disk
- Variable file size operation
- The time stamp information of the first trigger event in a file is recorded as the updated date property of the file
- Can be used in Disk or RAM recording mode

Basic Action of Continuous Recording

This section describes how files are recorded by the location of the trigger events in Continuous Recording.

In the following explanation, both pretrigger and posttrigger sizes must be set to 500 MB.

- In general, each trigger event occurs intermittently. In this case, each file has one trigger event in the file, and the pretrigger and posttrigger areas have the specified size.

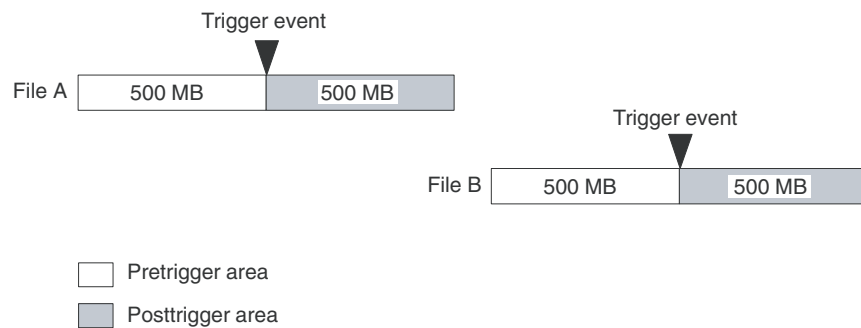

- If a trigger event occurs while the pretrigger area is filled with data, the pretrigger area becomes smaller than the specified size. However, the posttrigger area stays the specified size. In this case, File A is smaller than the specified size.

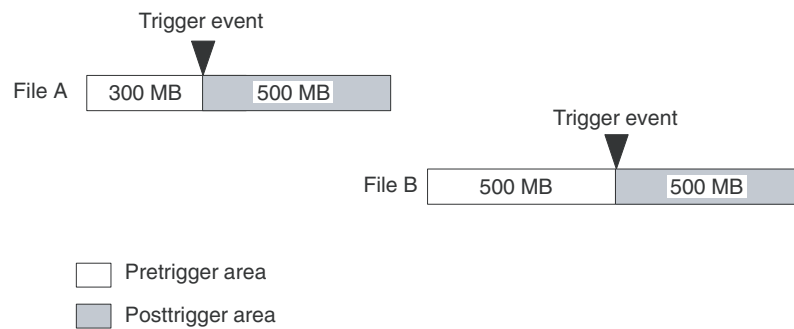

- If a second trigger event occurs while the posttrigger area is filled with data, the second trigger event is ignored.

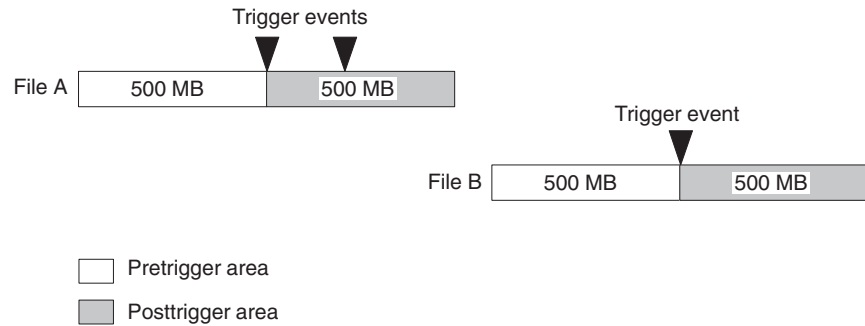

NOTE. If the trigger position is set to 0 (%), both files are created whenever a trigger event occurs.

Performing Continuous Recording

Use the following procedure to perform Continuous Recording:

1. Press the front-panel **REC** button to display the **Record** screen.
2. Select **File > Save** to open the **Save as** dialog box.
3. In the dialog box, select the folder where stream files are to be saved.
4. Select **Record > Target** to open the **Target** dialog box.
5. In the dialog box, enable the **Continuous Recording** check box (see Figure 3-19).

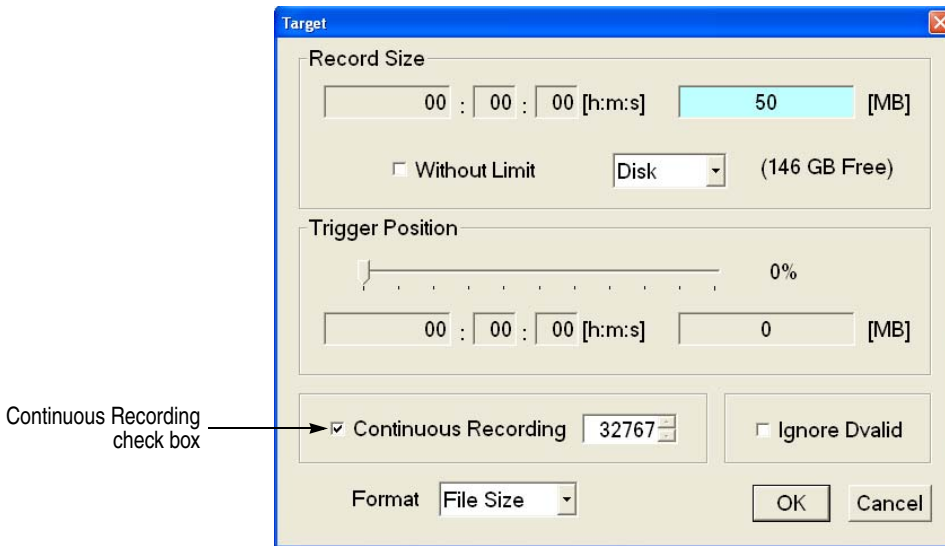

Figure 3-19: Continuous Recording check box

6. In the spin box at the right side of the check box, set the number of files to stop Continuous Recording. After the specified number of files are created, stream capture stops automatically.
7. In the **Record Size** field, set the file size to be recorded.
8. In the **Trigger Position** field, set the trigger position.
9. If you want to start recording by a trigger signal on the Trig In/Out connector:
 - a. Select **Record > Other** to open the Others dialog box.
 - b. Select **Rise** or **Fall** in the **Ext Record Start** field.
10. Press the front-panel **REC** button to start continuous recording.

While Continuous Recording is running, the total number of captured files are displayed in the file counter on the record status indicator (see Figure 3-20).

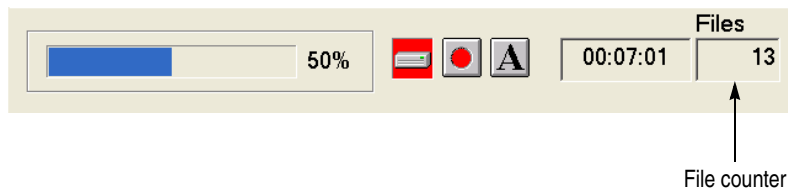

Figure 3-20: File counter

When the specified number of files are created or you press the front-panel STOP button, stream capture stops.

After the stream capture stops, recording of the captured streams starts. The file counter value decreases every time recording of each file is complete. The recording starts from the last captured file. If you press the STOP button while the captured streams are recording, the recording process terminates to the file currently being recorded.

NOTE. *The error message Drive Full appears when there is no space to record a captured file with the specified file size on the hard disk.*

Preset File

The MTX100A provides the capability to save the user-defined instrument settings as a preset file and load the instrument settings saved as a preset file. This section describes the contents of the instrument settings saved as a preset file and how to save and load a preset file.

Contents of the Preset File

The preset file can be created from either the Play screen or the Record screen. In the Play screen, you can save settings for stream output. In the Record screen, you can save settings for stream record.

- In the Play screen, all of the parameter settings available in the Play menu are saved as a preset. If any of the interface options are installed, the output parameter settings of the module are also saved.
- In the Record screen, all of the parameter settings available in the Record menu are saved as a preset. If any of the interface options are installed, the input parameter settings of the module are also saved.

Saving a Preset File

Use this procedure to save the current instrument settings as a preset file.

Perform the following steps to save a preset file:

1. Set the instrument settings that you want to save.
2. Select **File > Save Preset**, and then press the **ENTER** button. The **Save As** dialog box appears as shown in Figure 3-21.

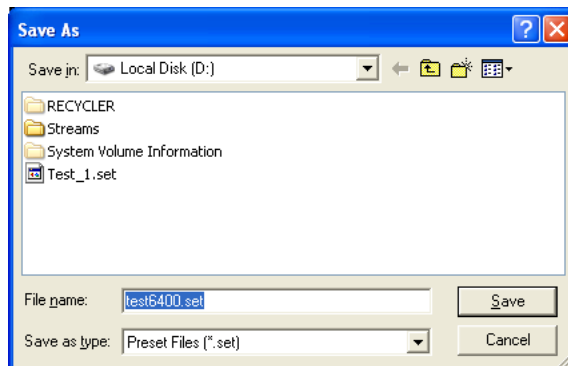

Figure 3-21: Save As dialog box

In the File name text box, the following default file name is displayed automatically:

- In the Play Screen, a two-digit serial number is added to the selected file name (for example, if the selected file name is Test_TS, the default file name becomes Test_TS00).
- In the Record Screen, Preset## (## represents a two-digit serial number) is used as a file name.

When a keyboard is connected to the USB connector, you can enter the desired file name.

3. Press the **ENTER** button. This saves the instrument settings as a preset file.

Loading a Preset File

Use this procedure to load instrument settings saved as a preset file.

Perform the following steps to load a preset file:

1. Select **File > Load Preset**, and then press the **ENTER** button. The **Open** dialog box appears as shown in Figure 3-22.

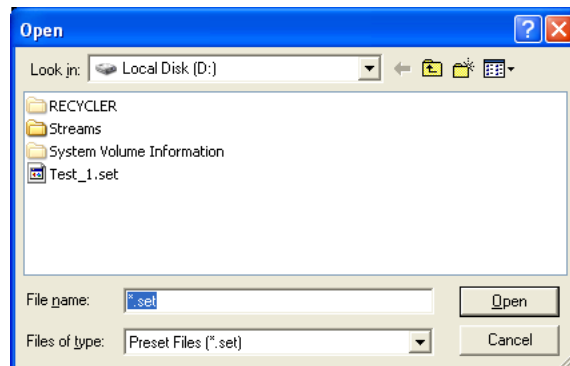

Figure 3-22: Open dialog box

2. Press the **TAB** button repeatedly to select the file displayed at the top of the file list. When the file is selected, broken lines are showed around the file name.
3. Press the up (▲) or down (▼) arrow button to select the preset file that you want to load. The selected file name is displayed in the File Name text box.
4. Press the **ENTER** button. This loads the preset file into the instrument.

Connecting to a Network

The MTX100A has a LAN (10/100/1000 Base-T) port on the rear panel for Ethernet communications.

This section provides instructions for connecting the MTX100A to a single PC or a network and setting the network parameters for the LAN port.

Connecting the MTX100A to your PC(s)

The MTX100A uses the rear-panel LAN port (see Figure 2-2 on page 2-4) to communicate with a PC. Use one of the following two methods to connect the MTX100A to your PC(s).

- If you are connecting the MTX100A directly to a single PC, use a crossover Ethernet cable to connect between the LAN port on the MTX100A and the Ethernet port on the PC. If you need to construct your own crossover cable, Figure 3-23 shows the pin connections to change on a straight cable to produce a crossover cable.
- If you are connecting the MTX100A to your local Ethernet network, use a straight Ethernet cable to connect between the LAN port on the MTX100A and the Ethernet hub port of your local network. By connecting to an Ethernet network, you can access the MTX100A using any PC on the network.

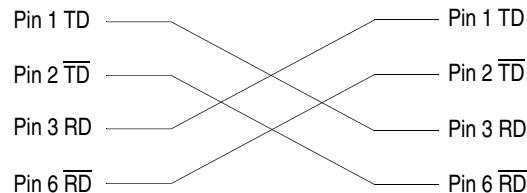

Figure 3-23: Pin connections for a crossover Ethernet cable

Setting Ethernet Network Parameters

You can set the network parameters for the MTX100A using the Control Panel of Windows XP.

NOTE. *The following procedure assumes that you are familiar with the basics of using the Windows XP operating system. If necessary, review the Windows XP documentation.*

Perform the following procedure to set the network parameters for the MTX100A.

1. Connect the keyboard and mouse provided with the instrument to the USB connectors on the front panel. You can connect them to either of the connectors.
2. Select **Minimize** or **Exit** from the **File** menu to close the Play (or Record) screen. The Windows XP desktop appears.
3. Select **Settings** > **Control Panel** from the **Start** menu. The Control Panel window appears.
4. Double-click the **Network Connections** icon in the window. The **Network Connections** window appears as shown in Figure 3-24.

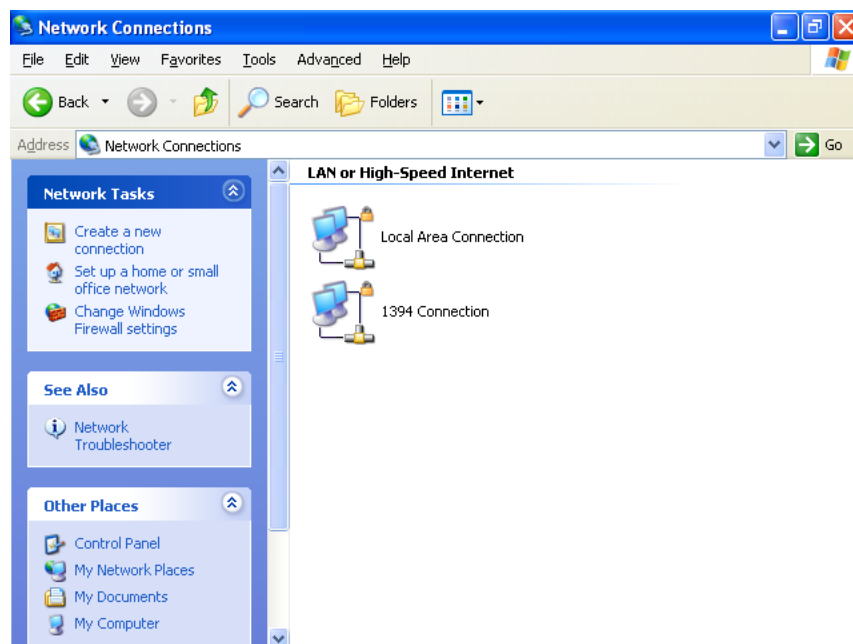

Figure 3-24: Network Connections window

5. Double-click the **Local Area Connection** icon. The **Local Area Connection Status** dialog box appears as shown in Figure 3-25.

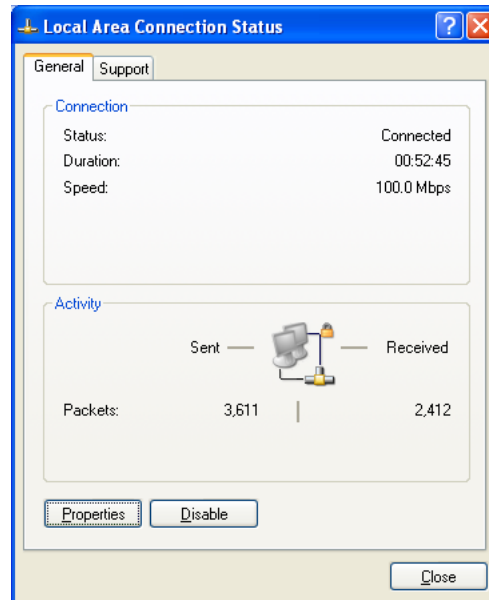

Figure 3-25: Local Area Connection Status dialog box

6. Click the **Properties** button. The **Local Area Connection Properties** dialog box appears as shown in Figure 3-26.

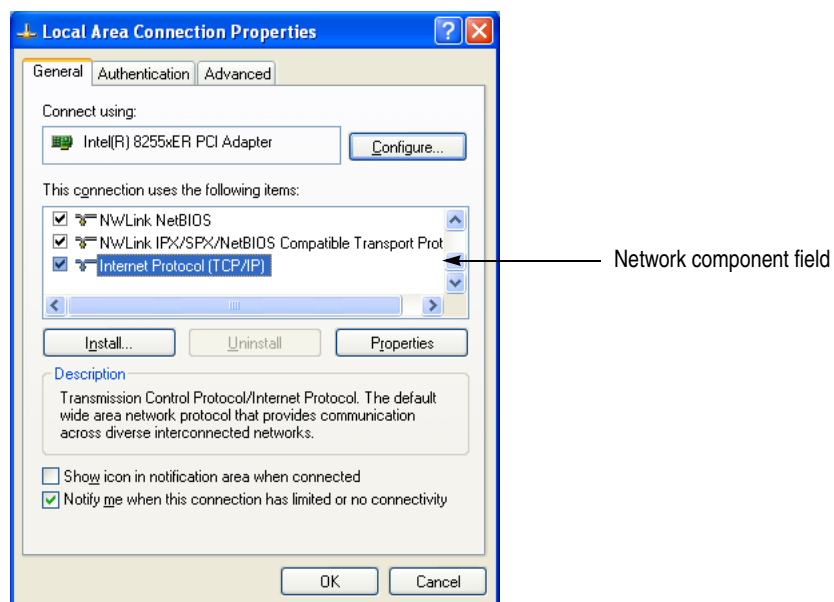

Figure 3-26: Local Area Connection Properties dialog box

7. In the network component field, click **Internet Protocol (TCP/IP)**.
8. Click the **Properties** button. The **Internet Protocol (TCP/IP) Properties** dialog box appears as shown in Figure 3-27.

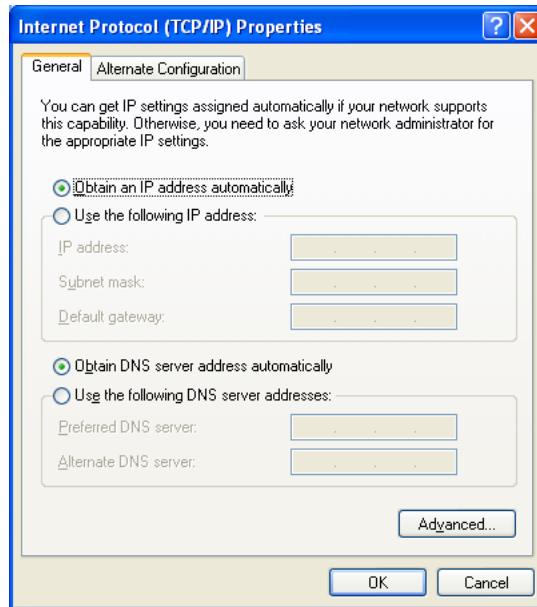

Figure 3-27: Internet Protocol (TCP/IP) Properties dialog box

The settings in the dialog box depend on whether a DHCP (Dynamic Host Configuration Protocol) server is in the network connected to the MTX100A.

When the DHCP Server is in the Network.

If the DHCP server is in the network, perform steps 9 and 10, otherwise skip to step 11.

9. In the dialog box, select the **Obtain an IP address automatically and Obtain DNS server address automatically** check boxes.
10. Click the **OK** button.

The MTX100A accesses the DHCP server and obtains the addresses automatically when connected to the network.

Refer to the user documentation supplied with your server OS for detailed information about DHCP server functions.

NOTE. *Under some network environments, the MTX100A may not be able to obtain the IP address automatically from a DHCP server. In this case, you need to enter the appropriate address value in each submenu item.*

When the DHCP Server is not in the Network.

If the DHCP server is not in the network, perform the following procedure to set the network parameters.

- 11.** If you connect the MTX100A directory to a single PC:
 - a.** In the dialog box, select the **Use the following IP address** check box.
 - b.** Set the **IP address** parameter to be the same IP address as the PC's address except for the last number. The last number must be different than the last number in the PC's IP address.
 - c.** Set the **Subnet mask** parameter to be the same net mask (subnet mask) used by the PC. Do not enter a number if the PC does not have a net mask.
 - d.** You do not need to enter a **Default gateway** if you are directly connected to a single PC.
- 12.** If you connect the MTX100A to your local Ethernet network:
 - a.** In the dialog box, select the **Use the following IP address** check box.
 - b.** Ask your local network administrator and set the appropriate addresses.



CAUTION. *To prevent communication conflicts on your Ethernet network, ask your local network administrator for the correct numbers to enter in the dialog box if you connect the MTX100A to your local Ethernet network.*

- 13.** Verify the Ethernet connection by using a ping command from the PC.

Outputting an ISDB-T Transport Stream

This section describes how to set up the MTX100A and how to connect the MTX100A and a modulator when you output an ISDB-T (Integrated Services Digital Broadcasting for Terrestrial) transport stream.

Perform the following procedure to output an ISDB-T transport stream from the MTX100A:

1. Press the **PLAY** button to display the Play screen.
2. Select the **Other** command from the **Play** menu to open the **Others** dialog box.
3. In the dialog box, select **ARIB** in the **Standard** field.

NOTE. Before the MTX100A can recognize an ISDB-T transport stream file, ARIB must be selected in the Standard field.

4. Select the **Open** command from the **File** menu to open the **Select File** dialog box.
5. In the dialog box, select the ISDB-T transport stream file that you want to output.

The hierarchy view of the transport stream file is displayed on the screen as shown in Figure 3-28.

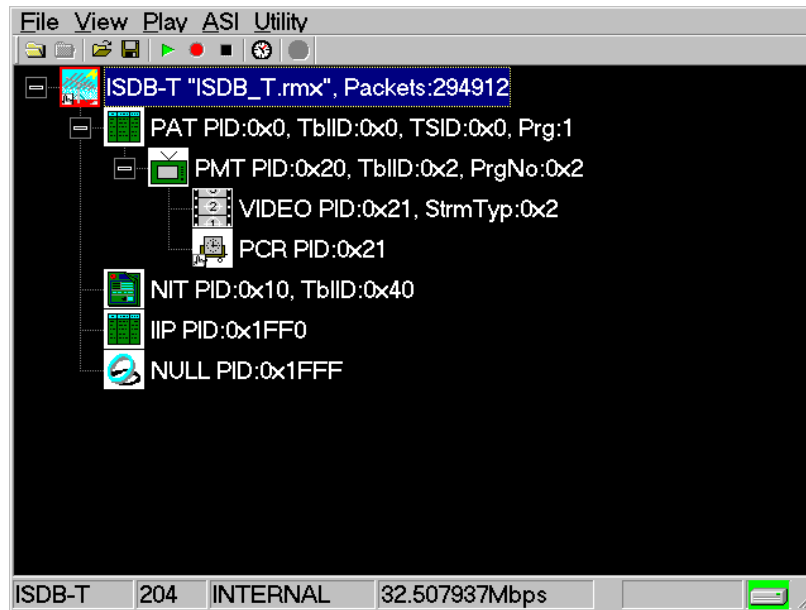

Figure 3-28: Hierarchy view of the ISDB-T transport stream file

6. Select the ISDB-T transport stream icon and press the front-panel SELECT button (or click the icon with the right mouse button) to open the ISDB-T Information dialog box, shown in Figure 3-29.

NOTE. The ISDB-T transport stream is different from the typical transport stream, so the icon is not represented as a train.

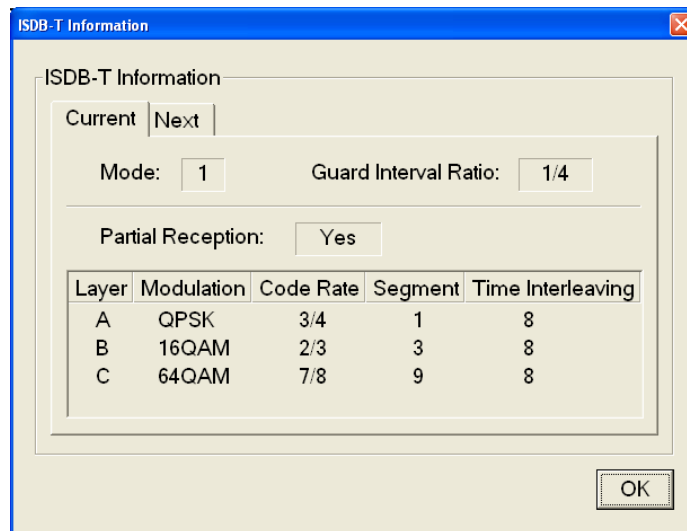

Figure 3-29: ISDB-T Information dialog box

Use this dialog box to check the transmission parameters of the ISDB-T transport stream.

For the MTX100A Other Than Option 02:

7. Use an interface cable to connect the **SPI In/Out** connector (or the output connector on the installed optional card) on the MTX100A and an ISDB-T modulator.
8. Press the **PLAY** button on the MTX100A to output the transport stream.

NOTE. For an ISDB-T transport stream, the MTX100A outputs the stream from the start packet in the OFDM frames to the maximum number of packets that can be looped as $2N$ of the number of OFDM frames. If any transport stream within the ISDB-T transport stream has different modulation parameters, select *Non TS* from the *Packet Size* command in the *Play* menu.

For the MTX100A Option 02:

9. Select **PI Clock** from the **Univ I/F** menu. This menu item is only available when an ISDB-T file is loaded.
10. In the displayed submenu, select the scale factor of the Packet Information clock to the TS clock (4 MHz).
11. Use an interface cable to connect the **SPI In/Out** connector on the MTX100A Option 02 and the TSP input on the ISDB-T modulator.

12. Use an interface cable to connect the **Universal In/Out** connector on the MTX100A Option 02 and the PI input on the ISDB-T modulator.

13. In the **Univ I/F** menu on the MTX100A Option 02, make the following settings:

Level LVDS
Format Parallel
Clock Rise

14. Press the **PLAY** button on the MTX100A Option 02 to output the transport stream.

NOTE. For an ISDB-T transport stream, the MTX100A outputs the stream from the start packet in the OFDM frames to the maximum number of packets that can be looped as $2N$ of the number of OFDM frames. If any transport stream within the ISDB-T transport stream has different modulation parameters, select *Non TS* from the *Packet Size* command in the *Play* menu.

At this time, the transport stream data is output from the SPI In/Out connector and the control signals for the hierarchical multiplexing parameters are output from the Universal In/Out connector.

Refer to *Appendix D: Control Signals for Option 02* for information about the pin assignments of the Universal In/Out connector and timing relationship of the output signals on the connector.

Syntax

This section contains information on the Standard Commands for Programmable Instruments (SCPI) and IEEE 488.2 Common Commands you can use to program your MTX100A. The information is organized in the following subsections:

SCPI Commands and Queries

SCPI is a standard created by a consortium that provides guidelines for remote programming of instruments. These guidelines provide a consistent programming environment for instrument control and data transfer. This environment uses defined programming messages, instrument responses, and data format across all SCPI instruments, regardless of manufacturer. The MTX100A uses a command language based on the SCPI standard.

The SCPI language is based on a hierarchical or tree structure (see Figure 3-30) that represents a subsystem. The top level of the tree is the root node; it is followed by one or more lower-level nodes.

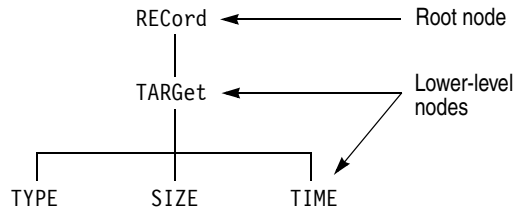

Figure 3-30: Example of SCPI subsystem hierarchy tree

You can create commands and queries from these subsystem hierarchy trees. Commands specify actions for the instrument to perform. Queries return measurement data and information about parameter settings.

Creating Commands

SCPI commands are created by stringing together the nodes of a subsystem hierarchy and separating each node by a colon.

In Figure 3-30, RECOrd is the root node and TARGet, TYPE, SIZE, and TIME are lower-level nodes. To create a SCPI command, start with the root node RECOrd and move down the tree structure adding nodes until you reach the end of a branch. Most commands and some queries have parameters; you must include a value for these parameters. If you specify a parameter value that is out of range, the parameter will be set to a default value.

For example, RECOrd:TARGet:TYPE DISK is a valid SCPI command created from the hierarchy tree in Figure 3-30.

Creating Queries

To create a query, start at the root node of a tree structure, move down to the end of a branch, and add a question mark. RECOrd:TARGet:TYPE? is an example of a valid SCPI query using the hierarchy tree in Figure 3-30.

Parameter Types

Every parameter in the command and query descriptions is of a specified type. The parameters are enclosed in brackets, such as <pattern>. The parameter type is listed after the parameter and is enclosed in parentheses, for example, (discrete). Some parameter types are defined specifically for the MTX100A command set and some are defined by ANSI/IEEE 488.2-1987 (see Table 3-21).

Table 3-21: Parameter types used in syntax descriptions

Parameter type	Description	Example
binary	Binary numbers	#B0110
arbitrary block ¹	A specified length of arbitrary data	#512234xxxx . . . where 5 indicates that the following 5 digits (12234) specify the length of the data in bytes; xxxxx ... indicates the data
boolean	Boolean numbers or values	ON or 1 OFF or 0
discrete	A list of specific value	MIN, MAX, UP, DOWN
hexadecimal	Hexadecimal numbers (0-9, A, B, C, D, E, F)	#HAA, #H1
NR1 ^{2,3} numeric	Integers	0, 1, 15, -1
NR2 ² numeric	Decimal numbers	1.2, 3.141516, -6.5
NR3 ² numeric	Floating point numbers	3.1415E-9, -16.1E5
NRf ² numeric	Flexible decimal number that may be type NR1, NR2, or NR3	See NR1, NR2, NR3 examples
string ⁴	Alphanumeric characters (must be within quotation marks)	"Testing 1,2,3"

1 Defined in ANSI/IEEE 488.2 as "Definite Length Arbitrary Block Response Data."

2 An ANSI/IEEE 488.2-1992-defined parameter type.

3 Some commands and queries will accept a hexadecimal value even though the parameter type is defined as NR1.

4 Defined in ANSI/IEEE 488.2 as "String Response Data."

Abbreviating Commands, Queries, and Parameters

You can abbreviate most SCPI commands, queries, and parameters to an accepted short form. This manual shows these short forms as a combination of upper and lower case letters. The upper case letters indicate the accepted short form of a command. As shown in Figure 3-31, you can create a short form by using only the upper case letters. The accepted short form and the long form are equivalent and request the same action of the instrument.

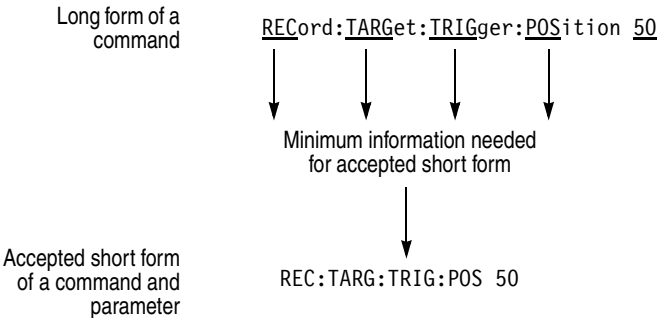

Figure 3-31: Example of abbreviating a command

Chaining Commands and Queries

You can chain several commands or queries together into a single message. To create a chained message, first create a command or query, add a semicolon (;), and then add more commands or queries and semicolons until you are done. If the command following a semicolon is a root node, precede it with a colon (:). Figure 3-32 illustrates a chained message consisting of several commands and queries. The single chained message should end in a command or query, not a semicolon. Responses to any queries in your message are separated by semicolons.

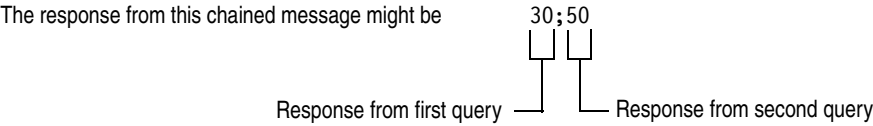
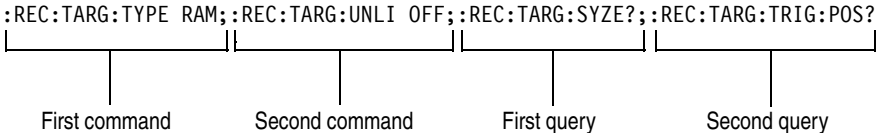

Figure 3-32: Example of chaining commands and queries

If a command has the same root and lower-level nodes as the previous command, you can omit these nodes. In Figure 3-33, the second command has the same root node (REC) and lower level node (TARG) as the first command, so these nodes can be omitted.

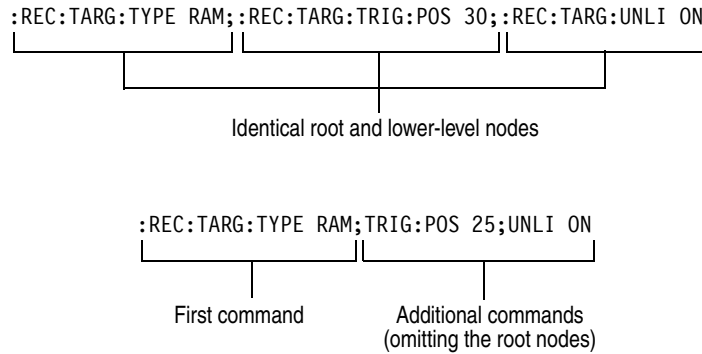

Figure 3-33: Example of omitting root and lower-level nodes in a chained message

General Rules

Here are three general rules for using SCPI commands, queries, and parameters:

- You can use single (‘ ’) or double (“ ”) quotation marks for quoted strings, but you cannot use both types of quotation marks for the same string.

correct: “This string uses quotation marks correctly.”

correct: ‘This string also uses quotation marks correctly.’

incorrect: “This string does not use quotation marks correctly.’

- You can use upper case, lower case, or a mixture of both cases for all commands, queries, and parameters.

RECORD:TARGET:TRIGGER:POSITION 50

is the same as

record::position target:trigger50

and

RECORD:target:trigger:POSITION 50

NOTE. *Literal strings (quoted) are case sensitive. For example: file names.*

- No embedded spaces are allowed between or within nodes.

correct: RECORD:TARGET:TRIGGER:POSITION 50

incorrect: RECORD: TARGET: TRIGGER: POSI TION 50

IEEE 488.2 Common Commands

Description ANSI/IEEE Standard 488.2 defines the codes, formats, protocols, and usage of common commands and queries used on the interface between the controller and the instruments. The MTX100A complies with this standard.

Command and Query Structure The syntax for an IEEE 488.2 common command is an asterisk (*) followed by a command and, optionally, a space and parameter value. The syntax for an IEEE 488.2 common query is an asterisk (*) followed by a query and a question mark. All of the common commands and queries are listed in the last part of the *Syntax and Commands* section. The following are examples of common commands:

- *ESE 16
- *CLS

The following are examples of common queries:

- *ESR?
- *IDN?

Backus-Naur Form Definition This manual may describe commands and queries using the Backus-Naur Form (BNF) notation. Table 3-22 defines the standard BNF symbols:

Table 3-22: BNF symbols and meanings

Symbol	Meaning
< >	Defined element
: :=	Is defined as
	Exclusive OR
{ }	Group; one element is required
[]	Optional; can be omitted
...	Previous element(s) may be repeated
()	Comment

Remote Commands

This section describes the remote command set that is used in the MTX100A. The commands for the MTX100A are divided into the following six groups:

- Common commands
- DISPLAY commands
- MASS MEMORY commands
- PLAY commands
- RECORD commands
- SYSTEM commands

This section also contains commands that are used to control the optional interface cards.

The MTX100A can be controlled remotely through the LAN port on the rear panel. Refer to *Connecting to a Network* on page 3-67 for detailed information about how to connect and set up for remote operation.

Common Commands

The Common commands have a “*” prefix and address of all the instruments that support IEEE 488.2.

Command Tree

*CLS
*ESE(?)
*ESR?
*IDN?
*LRN?
*OPC(?)
*OPT?
*RST
*SRE(?)
*STB?
*TRG
*TST?
*WAI

Command Description

*CLS

Clears SESR (Standard Event Status Register), the SBR (Status Byte Register), and Event Queue, which are used in the instrument status and event reporting system.

*ESE

Sets the bits of the ESER (Event Status Enable Register) used in the status and events reporting system.

*ESE?

Returns the contents of the ESER.

*ESR?

Returns the contents of SESR (Standard Event Status Register) used in the status and events reporting system.

*IDN?

Returns the ID information of the instrument. The ID information contains manufacturer, model, firmware version, hardware version, and FPGA code version.

*LRN?

Returns the current instrument settings.

*OPC

Causes bit 0 in the SESR (Standard Event Status Register) to be set, and the operation complete message to be issued, when all pending operations are finished. This command is only available just after the :PLAY:START or :RECORD:START command is executed.

*OPC?

Waits until all pending operations are finished and returns a "1" ASCII character. This query is only available just after the :PLAY:START or :RECORD:START command is executed.

*OPT?

Lists the installed interface option.

*RST

Resets the instrument to the factory default state. This command has the same effect when the :SYSTEM:PRESET and *CLS commands are executed successively.

*SRE

Sets the bits of the SRER (Service Request Enable Register).

*SRE?

Returns the contents of SRER.

*STB?

Returns the value of the SBR (Status Byte Register). Bit 6 of the SBR is read as a MSS (Master Status Summary) bit.

*TRG

Generates a trigger event.

*TST?

Performs the self test and returns its result. The MTX100A always returns 1.

*WAI

Wait-to-continue command. This command is not necessary since the MTX100A handles commands sequentially.

DISPLAY Commands

Use these commands to select a display format of the base value in the hierarchy display.

Command Tree

```
:DISPlay
  :VIEW
    :FORMat          HEXadecimal|DECimal|OCTal
```

Command Description

```
:DISPlay:VIEW:FORMat HEXadecimal|DECimal|OCTal
```

Sets the base value used to describe the component information in the hierarchy display. The choices are HEXadecimal, DECimal, and OCTal. The default value is HEXadecimal.

```
:DISPlay:VIEW:FORMat?
```

Returns the current display format of the base value in the hierarchy display.

MASS MEMORY Commands

Use these commands to perform file related operations such as changing and moving a directory, and loading and saving a preset.

Command Tree

```
:MMEMory
  :CATalog?          [<directory_path>]
  :CDIRECTory
    [:DATA]          <directory_path>
    :STATE           <directory_path>
  :LOAD
    :STATE           <preset_name>
  :MDIRECTory        <directory_path>
  :STORE
    :STATE           <preset_name>
```

Command Description

`:MMEemory:CATalog? [<directory_path>]`

Lists the files in the specified directory. The query response is as follows:
<used_bytes>, <available_bytes>, “<file_name>, <directory_flag>,
<file_size>, <date>,<time>”...

`:MMEemory:CDIRectory[:DATA] [<directory_path>]`

Changes the current directory for data files. The default value is D:.

`:MMEemory:CDIRectory[:DATA]?`

Returns the current directory for data files.

`:MMEemory:CDIRectory:STATe <directory_path>`

Changes the current directory for setting files. The default value is D:.

`:MMEemory:CDIRectory:STATe?`

Returns the current directory for setting files.

`:MMEemory:LOAD:STATe <preset_name>`

Loads the specified preset. This command accepts the name of a previously saved preset. Current instrument settings are overwritten by this command.

`:MMEemory:MDIRectory <directory_path>`

Creates a subdirectory. The command is invalid if a directory with the specified name already exists.

`:MMEemory:STORe:STATe <preset_name>`

Saves the instrument settings with the specified preset name.

PLAY Commands

Use these commands to set parameters related to the stream output. These include packet size, output clock rate, data output source, and PCR jitter insertion.

Command Tree

```

:PLAY
  :AUTOplay      ON|OFF
  :CLOCK
    :DEfault
      :RATE      <numeric_value>
      :RATE
        :RATIo   <numeric_value>,<numeric_value>
    :ESRatefixed ON|OFF
    :ISDBT
      :CONVert   ON|OFF
      :RATE      <numeric_value>
      :RATE
        :RATIo   <numeric_value>,<numeric_value>
    :SOURceI     NTERNAL|EXT10M|EXT27M|EXTIfft|
                  EXTParallel|EXTSerial
  :EXTERNAL     RISE|FALL|OFF
  :EXTTrigger
    :BNC        INPUT|OUTPUT
    :OUTPUT
      :DELAy    <numeric_value>
      :SELEct   C27M|ISDBT
  :LOAD
    :FILE       <file_name>
  :LOOP         ON|OFF
    :ISDBT
      :FRAME    ON|OFF
  :PACKet       188|204|208|NONTs
  :PCR
    :INITial    <numeric_value>,<numeric_value>
    :INACcuracy NONE|SINe|SQUare|TRIangle|PULSe|SAW|
                  RANDom|OFFSet[,,<numeric_value>,<numeric_value>[,<numeric_value>[,<numeric_value>]]]
  :S192F
    :PARTialts  ON|OFF
  :SOURce       RAM|DISK
  :SPIOoutput   ON|OFF
  :SSPOsition
    :INITial
      :ENABle   ON|OFF

```

[:POSition]	<numeric_value>
:TIME	<string>
[:POSition]	<numeric_value>,<numeric_value>
:TIME	<string>,<string>
:STANdard?	
:STARt	
:STOP	
:SYNC	
:PSYNc	TSPacket SF NONTs
:INTERval	NONE <numeric_value>
:DVALid	
:WIDth	NONE <numeric_value>
:TIMEpacket	
:DEFine	<numeric_value>,<numeric_value>, <numeric_value>,<numeric_value>, <numeric_value>,<numeric_value>
:MODE	ORIGInal OS USER
:UPDAtE	ON OFF
:ITEM	
:CC	ON OFF
:NPT	ON OFF
:PCR	ON OFF
:METHod	HARDWare SOFTWare
:REEDsolomon	ON OFF
:TIMEpacket	ON OFF

Command Description

:PLAY:AUTOplay ON|OFF

Sets whether the selected stream is automatically output using the last power-down settings when you turn the MTX100A on. You can use 1 or 0 instead of ON or OFF. The default value is OFF.

:PLAY:AUTOplay?

Return the current auto play mode status.

:PLAY:CLOCK:DEFault:RATE <numeric_value>

Sets the default clock rate that is automatically set when the selected stream file is downloaded. Since the clock rate is calculated based on the PCRs in the file, the value may be different from the original clock rate. If this happens, you can set the appropriate value by this command. You can set the rate from 0.001 MHz to 250.0 MHz. If you change the value, the :PLAY:CLOCK:RATE command setting will set to the same value. The default value is 56.61.

:PLAY:CLOCK:DEFault:RATE?

Returns the default clock rate that is automatically set when the selected stream file was downloaded.

:PLAY:CLOCK:DEFault:RATE:RATIo <numeric_value>,<numeric_value>

Sets the default clock rate that is automatically set when the selected stream file is downloaded using a fraction. Since the clock rate is calculated based on the PCRs in the file, the value may be different from the original clock rate. If this happens, you can set the appropriate value by this command. The first argument represents a numerator and the second represents a denominator. You can set both values from 0 to 2000000000. If you change the value, the :PLAY:CLOCK:RATE:RATIo command setting will set to the same value. The default values are 629 for the numerator and 300 for the denominator.

:PLAY:CLOCK:DEFault:RATE:RATIo?

Returns the default clock rate that is automatically set when the selected stream file is downloaded using a fraction.

:PLAY:CLOCK:ESRAtfixed ON|OFF

Sets whether the elementary stream rate is fixed. When you select ON, the elementary stream rate becomes constant regardless of the clock rate setting. You can use 1 or 0 instead of ON or OFF. The default value is OFF.

:PLAY:CLOCK:ISDBT:CONVert ON|OFF

Sets whether the clock rate is automatically set when the data file for ISDB-TSB is loaded. When you select ON, the clock rate is automatically set to $(2048/1701) \times 27$ MHz and the elementary stream rate becomes constant regardless of the :PLAY:CLOCK:ESRAtfixed command setting. You can use 1 or 0 instead of ON or OFF. The default value is ON.

:PLAY:CLOCK:ISDBT:CONVert?

Returns whether the clock rate is automatically set when the data file for ISDB-TSB is loaded.

:PLAY:CLOCK:ESRAtfixed?

Returns the current elementary stream rate status.

:PLAY:CLOCK:RATE <numeric_value>

Sets the clock rate for the stream output. You can set the rate from 0.001 MHz to 250.0 MHz. The default value is 56.61.

:PLAY:CLOCK:RATE?

Returns the current clock rate for the stream output.

:PLAY:CLOCK:RATE:RATIO <numeric_value>,<numeric_value>

Sets the clock rate for the stream output using a fraction. The first argument represents a numerator and the second represents a denominator. You can set both values from 0 to 2000000000. The default values are 629 for the numerator and 300 for the denominator.

:PLAY:CLOCK:RATE:RATIO?

Returns the current clock rate for the stream output using a fraction.

:PLAY:CLOCK:SOURCE INTERNAL|EXT10M|EXT27M|EXTIfft|EXTParallel|
EXTSerial

Sets which clock to use as the reference for the stream output. The choices are:

INTERNAL: uses the internal clock.

EXT10M: uses a 10 MHz signal on the Clock/Ref In connector.

EXT27M: uses a 27 MHz signal on the Clock/Ref In connector.

EXTIfft: uses an IFFT sample clock signal (8.126984 MHz) on the Clock/Ref In connector.

EXTParallel: uses a clock signal on the Clock/Ref In connector as a parallel clock.

EXTSerial: uses a clock signal on the Clock/Ref In connector as a serial clock.

:PLAY:CLOCK:SOURCE?

Returns the current reference clock for the stream output.

:PLAY:EXTERNAL RISE|FALL|OFF

Sets whether to start stream output using a trigger signal applied to the Trig In/Out connector. The choices are RISE, FALL, and OFF. When you select RISE, the stream output is started at the rising edge of the applied trigger signal. When you select FALL, the stream output is started at the falling edge of the applied trigger signal. The default value is OFF.

:PLAY:EXTERNAL?

Returns whether to start stream output using a trigger signal applied to the Trig In/Out connector.

`:PLAY:EXTTrigger:BNC INPUT|OUTPut`

Sets whether to use the rear-panel Trig In/Out connector as an input or an output. For INPUt, the connector can be used to input an external trigger signal. For OUTPut, the connector can be used to output a 27 MHz reference clock or an ISDB-T frame pulse signal. Use the `:PLAY:EXTTrigger:OUTPut:SELEct` command to select which signal is output from the connector. The default value is INPUt.

`:PLAY:EXTTrigger:BNC?`

Returns the current input/output status of the Trig In/Out connector.

`:PLAY:EXTTrigger:OUTPut:DELAy <numeric_value>`

Sets the amount of delay for the start packet pulse of the ISDB-T frame in 1-parallel clocks of the SPI output. You can set the value from 0 to 15. The default value is 0.

`:PLAY:EXTTrigger:OUTPut:DELAy?`

Returns the current amount of delay for the start packet pulse of the ISDB-T frame.

`:PLAY:EXTTrigger:OUTPut:SELEct C27M|ISDBT`

Selects which signal to output from the Trig In/Out connector when the `:PLAY:EXTTrigger:BNC` command is set to OUTPut. The choices are C27M and ISDBT. For C27M, a 27 MHz reference clock signal is output. For ISDBT, an ISDB-T frame pulse signal is output. The default value is C27M.

`:PLAY:EXTTrigger:OUTPut:SELEct?`

Returns the current output signal selection when the Trig In/Out connector is used as an output.

`:PLAY:LOAD:FILE <file_name>`

Loads the specified stream file.

`:PLAY:LOAD:FILE?`

Returns the name of the file currently loaded.

`:PLAY:LOOP ON|OFF`

Sets whether the selected stream is output using the looping method. When you select ON, the stream is continuously output. The default value is ON.

`:PLAY:LOOP?`

Returns the current output loop mode status.

`:PLAY:LOOP:ISDBT:FRAME ON|OFF`

Sets whether to output an ISDB-T transport stream in OFDM frames when looped. When you select OFF, an ISDB-T transport stream is looped in packets. You can use 1 or 0 instead of ON or OFF. The default value is ON.

`:PLAY:LOOP:ISDBT:FRAME?`

Returns whether to output an ISDB-T transport stream in OFDM frames when looped.

`:PLAY:PACKet 188|204|208|NONTs`

Sets the packet size for the selected stream file. The choices are 188, 204, 208, and NONTs (Non TS). The default value is 188.

`:PLAY:PACKet?`

Returns the current packet size setting for the selected stream file.

`:PLAY:PCR:INITial <numeric_value>,<numeric_value>`

Sets the initial value of the `program_clock_reference_base` and `program_clock_reference_extension` parameters. You can set the `program_clock_reference_base` value from 0 to 8589934591 and set the `program_clock_reference_extension` value from 0 to 299. The default values are both 0.

`:PLAY:PCR:INITial?`

Returns the current initial value of the `program_clock_reference_base` and `program_clock_reference_extension` parameters.

```
:PLAY:PCR:INACcuracy NONE|SINE|SQUare|TRIangle|PULSe|SAW|
    RANDom|OFFSet [,<PID>,<amplitude>
    [<period>[,<pulse_width>]]];
```

Sets the PCR jitter insertion. Use the first argument to set the waveform type used to add jitter. When NONE is selected, the jitter insertion is disabled. Use the second to fifth arguments to set the PID of the PCRs, the amplitude of the waveform, the period of the waveform, and pulse width of the waveform. The pulse width is available only when the waveform is set to PULSe. The ranges of each argument are as follows:

```
PID: 0 to 8191
Amplitude: 0 to 135000000
Period: 5 to 3000
Pulse width: 1 to (period -1)
```

```
:PLAY:PCR:INACcuracy?
```

Returns the current PCR jitter insertion settings.

```
:PLAY:S192F:PARTialts ON|OFF
```

Sets whether to output a stream file consisting of a 192-byte packet as a partial transport stream. When you select OFF, the stream is output in Non TS format. You can use 1 or 0 instead of ON or OFF. The default value is ON.

```
:PLAY:S192F:PARTialts?
```

Returns whether to output a stream file consisting of a 192-byte packet as a partial transport stream.

```
:PLAY:SOURce RAM|DISK
```

Sets the source for stream output. The choices are RAM (system RAM) and DISK (hard disk). The default value is DISK.

```
:PLAY:SOURce?
```

Returns the current source setting for stream output.

```
:PLAY:SPIOoutput ON|OFF
```

Sets whether the signal output from the SPI In/Out connector is enabled. You can use 1 or 0 instead of ON or OFF. The default value is ON.

```
:PLAY:SPIOoutput?
```

Returns the current output status of the SPI In/Out connector.

`:PLAY:SSPOsition:INITial:ENABLE ON|OFF`

Sets whether to enable to set the initial start position of the selected stream to be looped. You can use 1 or 0 instead of ON or OFF. The default value is OFF.

`:PLAY:SSPOsition:INITial:ENABLE?`

Returns the current state of the initial start position setting.

`:PLAY:SSPOsition:INITial[:POsition] <numeric_value>`

Sets the initial start position of the selected stream to be looped by the number of packets (the number of super frames for M-TMCC file, or the number of bytes for a Non-TS file). The setting range depends on the `:PLAY:SSPOsition[:POsition]` command settings. The default value is 0.

`:PLAY:SSPOsition:INITial[:POsition]?`

Returns the current initial start position of the selected stream by the number of packets.

`:PLAY:SSPOsition:INITial:TIME <string>`

Sets the initial start position of the selected stream to be looped by time (hh:mm:ss). The setting range depends on the `:PLAY:SSPOsition:TIME` command settings. The default value is 00:00:00.

`:PLAY:SSPOsition:INITial:TIME?`

Returns the current initial start position of the selected stream by time.

`:PLAY:SSPOsition[:POsition]<numeric_value>,<numeric_value>`

Sets the loop start and stop positions of the selected stream to be looped by the number of packets (the number of super frames for M-TMCC file, or the number of bytes for a Non-TS file). Specify the start position in the first argument and specify the stop position in the second argument. You can set the positions from 0 to (available maximum value of the selected stream file). The default values are both 0.

`:PLAY:SSPOsition[:POsition]?`

Returns the current loop start and stop position settings of the selected stream by the number of packets.

`:PLAY:SSPOsition:TIME <string>,<string>`

Sets the loop start and stop positions of the selected stream to be looped by time (hh:mm:ss). Specify the start time in the first argument and specify the stop time in the second argument. You can set the time from 0 to (available maximum value of the selected stream file). The default values are both 00:00:00.

`:PLAY:SSPOsition:TIME?`

Returns the current loop start and stop position settings of the selected stream by time (hh:mm:ss).

`:PLAY:STANdard?`

Returns the standard of the loaded stream file. The available responses are MPEG, ARIB, ATSC, DVB, NONTs, MTMCc, STMCc, or ISDBT. The MTMCc, STMCc, and ISDBT standards are checked only when the `:SYSTem:STANdard` command is set to ARIB.

`:PLAY:STARt`

Starts outputting the selected stream. There are no arguments.

`:PLAY:STOP`

Stops outputting the selected stream. There are no arguments.

`:PLAY:SYNC TSPacket|SF|NONTs`

Sets the format of the PSYNC signal output from the SPI In/Out connector. For TSPacket, a single pulse signal is output at the start point of each packet. For SF, a single pulse is output at the start point of the SF appearing every 204x48x8 bytes. For NONTs, you can set the output period and data width of the PSYNC signal using the `:PLAY:SYNC:PSYNc:INTerval` command and `:PLAY:SYNC:PSYNc:WIDTh` commands. SF is available only when MTMCc is returned by the `:PLAY:STANdard?` query. The default value is TSPacket.

`:PLAY:SYNC?`

Returns the current format setting of the PSYNC signal.

`:PLAY:SYNC:DVALid:WIDTh NONE|<numeric_value>`

Sets the status and data width of the DVALID signal when NONTs is selected in the `:PLAY:SYNC` command. When you select NONE, the DVALID signal is disabled. You can set the width from 16 bytes to 255 bytes. This value cannot be set more than the value set by the `:PLAY:SYNC:PSYNc:INTerval` command. The default value is 188.

`:PLAY:SYNC:DVALid:WIDTH?`

Returns the current status and data width of the DVALID signal.

`:PLAY:SYNC:PSYnc:INTerval NONE|<numeric_value>`

Sets the status and output period of the PSYNC signal when NONTs is selected in the `:PLAY:SYNC` command. When you select NONE, the PSYNC signal is disabled. You can set the interval from 16 bytes to 255 bytes. This value needs to be set equal to or greater than the value in the `:PLAY:SYNC:DVALid:WIDTH` command. The default value is 188.

`:PLAY:SYNC:PSYnc:INTerval?`

Returns the current status and output period of the PSYNC signal.

`:PLAY:TIMEpacket:DEFine <numeric_value>,<numeric_value>,
<numeric_value>,<numeric_value>,
<numeric_value>,<numeric_value>`

Sets the initial values of the TDT, TOT, or STT when selected USER in the `:PLAY:TIMEpacket:MODE` command. The arguments are `<year>`, `<month>`, `<date>`, `<hour>`, `<minute>`, and `<second>`. You can set the values from 1900,3,1,0,0,0 to 2038,4,22,23,59,59 for the TDT and TOT and from 1980,1,6,0,0,0 to 2116,2,12,6,28,15 for the STT. The default values are the current date and time.

`:PLAY:TIMEpacket:DEFine?`

Returns the current data and time settings of the TDT, TOT, or STT.

`:PLAY:TIMEpacket:MODE ORIGINAL|OS|USER`

Selects the reference time used to set the initial value of the TDT, TOT, or STT when the `:PLAY:UPDAte` command is set to ON. The choices are ORIGINAL, SYSTem, and USER. For ORIGINAL, the original (default) value defined in the selected stream is used. For OS, the clock/calendar of the operating system is used. For USER, you can set any value in the `:PLAY:TIMEpacket:DEFine` command. The default value is ORIGINAL.

`:PLAY:TIMEpacket:MODE?`

Returns the current reference time selection used to set the initial value of the TDT, TOT, or STT.

`:PLAY:UPDAte ON|OFF`

Sets whether to update parameters in a stream when looped. You can select which parameters are updated using the `:PLAY:UPDAte:ITEM` commands. You can use 1 or 0 instead of ON or OFF. The default value is ON.

`:PLAY:UPDAte?`

Returns the current update mode status.

`:PLAY:UPDAte:ITEM:CC ON|OFF`

Sets whether to update `continuity_counter` values when the `:PLAY:UPDAte` command is set to ON. You can use 1 or 0 instead of ON or OFF. The default value is ON.

`:PLAY:UPDAte:ITEM:CC?`

Returns whether to update `continuity_counter` values when the `:PLAY:UPDAte` command is set to ON.

`:PLAY:UPDAte:ITEM:NPT ON|OFF`

Sets whether to update NPT values when the `:PLAY:UPDAte` command is set to ON. You can use 1 or 0 instead of ON or OFF. This command is only available when the `:PLAY:UPDAte:PCR` command is set to ON and the `:PLAY:UPDAte:ITEM:PCR:METHOD` command is set to SOFTWARE. The default value is OFF.

`:PLAY:UPDAte:ITEM:NPT?`

Returns whether to update NPT values when the `:PLAY:UPDAte` command is set to ON.

`:PLAY:UPDAte:ITEM:PCR ON|OFF`

Sets whether to update PCR/PTS/DTS values when the `:PLAY:UPDAte` command is set to ON. You can use 1 or 0 instead of ON or OFF. The default value is ON.

`:PLAY:UPDAte:ITEM:PCR?`

Returns whether to update PCR/PTS/DTS values when the `:PLAY:UPDAte` command is set to ON.

`:PLAY:UPDAte:ITEM:PCR:METHOD HARDware|SOFTWARE`

Sets the method to update PCR/PTS/DTS values. The choices are HARDware and SOFTWARE. The default value is HARDware.

`:PLAY:UPDAte:ITEM:PCR:MEthod?`

Returns the update method for PCR/PTS/DTS values.

`:PLAY:UPDAte:ITEM:REEDsolomon ON|OFF`

Sets whether to update Reed-Solomon symbols in an ISDB-T transport stream when the `:PLAY:UPDAte` command is set to ON. You can use 1 or 0 instead of ON or OFF. The default value is ON.

`:PLAY:UPDAte:ITEM:REEDsolomon?`

Returns whether to update Reed-Solomon symbols in an ISDB-T transport stream when the `:PLAY:UPDAte` command is set to ON.

`:PLAY:UPDAte:ITEM:TIMEpacket ON|OFF`

Sets whether to update TDT/TOT/STT values when the `:PLAY:UPDAte` command is set to ON. You can use 1 or 0 instead of ON or OFF. The default value is ON.

`:PLAY:UPDAte:ITEM:TIMEpacket?`

Returns whether to update TDT/TOT/STT values when the `:PLAY:UPDAte` command is set to ON.

RECORD Commands

Use these commands to set parameters related to the data record. These include input interface, record size, and trigger position.

Command Tree

```
:RECORD
  :ACQUIRE
    :START
    :STOP
  :CLOCK
    :RATE?
  :EXTERNAL          RISE|FALL|OFF
  :PACKET?
  :SOURCE           SPI|ASI|UNIVERSAL|I1394I|S310M|
                   STANDARD|OPTION
  :STANDARD?
  :START
  :STOP
  :STORE
    :FILE           <file_name>
    :MODE           NEWfile|OVERwrite
  :TARGET
    :IGNOREDVALID  ON|OFF
    :SIZE           <numeric_value>
    :TIME           <string>
    :TRIGGER
      :CONTINUOUS  ON|OFF
      :LIMIT       <numeric_value>
      :POSITION    <numeric_value>
  :TYPE             RAM|DISK
  :UNLIMIT         ON|OFF
```

Command Description

`:RECORD:ACQUIRE:START`

Starts input stream acquisition. When two or more record commands are sent to the instrument successively, the instrument stops stream acquisition and then starts stream acquisition for each command. Therefore, when many commands are sent to the instrument, it takes a long time to complete all settings. If you send the `:RECORD:ACQUIRE:STOP` command before sending record commands and send the `:RECORD:ACQUIRE:START` command after sending record commands, you can shorten the setting time.

`:RECORD:ACQUIRE:STOP`

Stops input stream acquisition. Refer to the `:RECORD:ACQUIRE:START` command description on how to use this command.

`:RECORD:CLOCK:RATE?`

Returns the clock rate of the input stream in MHz.

`:RECORD:EXTERNAL RISE|FALL|OFF`

Sets whether to start input stream record using a trigger signal applied to the Trig In/Out connector. The choices are RISE, FALL, and OFF. When you select RISE, the input stream record is started at the rising edge of the applied trigger signal. When you select FALL, the input stream record is started at the falling edge of the applied trigger signal. The default value is OFF.

`:RECORD:EXTERNAL?`

Returns whether to start input stream record using a trigger signal applied to the Trig In/Out connector.

`:RECORD:PACKET?`

Returns the packet size of the input stream. The available responses are 188, 204, 208, or NONTs. When the `:RECORD:I1394I:PARTIALts` command is set to ON, the response is 192.

`:RECORD:SOURCE SPI|ASI|UNIVERSAL||I1394I|S310M|STANDARD|OPTION`

Sets the interface used to capture a stream data. The choices are SPI, ASI, UNIVERSAL, I1394I (IEEE1394), S310M (SMPTE310M), STANDARD (same as SPI), and OPTION (optional interface currently installed). The default value is SPI.

:RECOrd:SOuRce?

Returns the current interface used to capture a stream data.

:RECOrd:STORe:FILE <file_name>

Specifies the file name used when the input stream is saved.

:RECOrd:STANdard?

Returns the current standard used to display the input stream. The available responses are MPEG, ARIB, ATSC, DVB, NONTs, MTMCc, STMCc, or ISDBT. The MTMCc, STMCc, and ISDBT standard are checked only when the :SYSTem:STANdard command is set to ARIB. When the RECOrd:I1394I PARTIalTs command is set to ON, the response is P_TS.

:RECOrd:STARt

Starts recording the input stream.

:RECOrd:STOP

Stops recording the input stream.

:RECOrd:STORe:FILE?

Returns the current file name used when the input stream is saved.

:RECOrd:STORe:MODE NEWfile|OVERwrite

Sets the save mode when the input stream is saved. The choices are NEWfile and OVERwrite. For NEWfile, a new file is created whenever you save a stream file. The file name is the following: The name specified by the :RECOrd:STORe:FILE command + # (1, 2, 3, 4...). For OVERwrite, the existing file is overwritten by the new file with the name specified in the :RECOrd:STORe:FILE command. The default value is OVERwrite.

:RECOrd:STORe:MODE?

Returns the current save mode setting when the input stream is saved.

:RECOrd:TARGet:TRIGger:IGNOredvalid ON|OFF

Sets whether the instrument ignores the DVALID signal from the selected interface when a stream data is acquired. When you select ON, the instrument ignores the DVALID signal, and the stream data is acquired according to the internal clock signal. You can use 1 or 0 instead of ON or OFF. The default value is OFF.

:RECOrd:TARGet:TRIGger:IGNOredval id?

Returns whether the instrument ignores the DVALID signal from the selected interface when a stream data is acquired.

:RECOrd:TARGet:SIZE <numeric_value>

Sets the file size to record the input stream in MB. You can set the file size from 1 to free space of the system RAM or hard disk. This setting changes the :RECOrd:TARGet:TIME command setting. The default value is 50 MB.

:RECOrd:TARGet:SIZE?

Returns the current file size setting to record the input stream.

:RECOrd:TARGet:TIME <string>

Sets the recording time (hh:mm:ss) to record the input stream. The minimum value of the setting range depends on the clock rate of the input stream. The maximum value of the setting range depends on the free space of the RAM or hard disk, or the clock rate of the input stream. This setting changes the :RECOrd:TARGet:SIZE command setting. The default value is 00:00:00.

:RECOrd:TARGet:TIME?

Returns the current recording time (hh:mm:ss) to record the input stream.

:RECOrd:TARGet:TRIGger:CONTInuous ON|OFF

Turns Continuous Recording on or off. When you select ON, you can record multiple stream files continuously on the hard disk. You can use 1 or 0 instead of ON or OFF. The default value is OFF.

:RECOrd:TARGet:TRIGger:CONTInuous?

Returns the current Continuous Recording state.

:RECOrd:TARGet:TRIGger:CONTInuous:LIMit <numeric_value>

Sets the number of files to stop Continuous Recording. You can set the value from 2 to 32767. The default value is 32767.

:RECOrd:TARGet:TRIGger:CONTInuous:LIMit?

Returns the number of files to stop Continuous Recording.

`:RECORD:TARGET:TRIGGER:POSITION <numeric_value>`

Sets the trigger position used to record the input stream. You can set the trigger position from 0% to 100%. The default value is 0%.

`:RECORD:TARGET:TRIGGER:POSITION?`

Returns the current trigger position setting.

`:RECORD:TARGET:TYPE RAM|DISK`

Sets the record target used to record the input stream. The choices are RAM and DISK (hard disk). The default value is DISK.

`:RECORD:TARGET:TYPE?`

Returns the current record target used to record the input stream.

`:RECORD:TARGET:TRIGGER:UNLIMIT ON|OFF`

Sets whether to record the input stream to the full free space in the hard disk or RAM. You can use 1 or 0 instead of ON or OFF. The default value is OFF.

`:RECORD:TARGET:TRIGGER:UNLIMIT?`

Returns whether to record the input stream to the full free space in the hard disk or RAM.

SYSTEM Commands

Use these commands to set or query the system related functions.

Command Tree

```
:SYSTEM
  :COMMunicate
    :SOCKet
      :PORT          <numeric_value>
      :RXTERM        CR|LF
      :TXTERM        CR|LF|CRLF|LFCR
    :ERRor[:NEXT]?
    :KLOCK[:STATe]  ON|OFF
    :MODE           PLAY|RECORD
    :OPTions?
    :PRESet
    :STANdard       MPEG|ARIB|ATSC|DVB
    :STATus?
```

Command Description

`:SYSTem:COMMunicate:SOCKet:PORT <numeric_value>`

Sets the port number needed to remotely control the instrument over an Ethernet network. You can set the value from 1024 to 65535. When you change the value, the current network connection is disconnected.

`:SYSTem:COMMunicate:SOCKet:PORT?`

Returns the current port number setting.

`:SYSTem:COMMunicate:SOCKet:RXTERM CR|LF`

Sets the terminator used when the MTX100A receives commands from a controller. The choices are CR (carriage return) and LF (linefeed). The default value is LF.

`:SYSTem:COMMunicate:SOCKet:RXTERM?`

Returns the terminator used when the MTX100A receives commands from a controller.

`:SYSTem:COMMunicate:SOCKet:TXTERM CR|LF|CRLF|LFCR`

Sets the terminator used when the MTX100A sends information to a controller. The choices are CR (carriage return), LF (linefeed), CRLF, and LFCR. The default value is CRLF.

`:SYSTem:COMMunicate:SOCKet:TXTERM?`

Returns the terminator used when the MTX100A sends information to a controller.

`:SYSTem:ERRor[:NEXT]?`

Returns an error message from the error/event queue. The response format is as follows:

`<error_code>,"<error_message>"`

Refer to *Error Messages and Codes* on page 3-119 for detailed information.

`:SYSTem:KLOCK[:STATe] ON|OFF`

Locks or unlocks the front-panel buttons and mouse operation. You can use 1 or 0 instead of ON or OFF. The default value is OFF.

`:SYSTem:KLOCK[:STATe]?`

Returns the current status of lock function.

:SYSTem:MODE PLAY|RECOrd

Sets the operation mode of the instrument. The choices are PLAY and RECOrd. The default value is PLAY.

:SYSTem:MODE?

Returns the current operation mode of the instrument.

:SYSTem:OPTions?

Returns the option number, hardware version, and code version of the installed interface card.

:SYSTem:PRESet

Resets the instrument to the factory default settings.

:SYSTem:STANdard MPEG|ARIB|ATSC|DVB

Sets the standard used to display the input stream. The choices are MPEG, ARIB, ATSC, and DVB. The default value is ARIB.

:SYSTem:STANdard?

Returns the current standard used to display the input stream.

:SYSTem:STATus?

Returns the current operation status of the instrument. The available responses are:

- 0: the instrument stops any operations
- 1: the instrument is outputting a data
- 2: the instrument is acquiring a data
- 3: the instrument is recording a data

Optional Commands

This subsection describes the commands that are used to control the optional interface cards. These commands are available only when the appropriate interface card is installed into the MTX100A.

Option 01 ASI Interface

`:PLAY:ASI:FORMat BYTE|PACKet`

Sets the output format of the ASI signal. The choices are `BYTE` and `PACKet`. For `BYTE`, valid data is output using a burst transmission mode. For `PACKet`, valid data is output in each transport stream packet. The default value is `PACKet`.

`:PLAY:ASI:FORMat?`

Returns the current output format setting of the ASI signal.

`:PLAY:ASI:THROughtout ON|OFF`

Sets the throughout mode; whether the signal applied to the ASI In connector is output from the ASI Out connector when a stream is not output. You can use 1 or 0 instead of `ON` or `OFF`. This setting changes the `:RECOrd:ASI:THROughtout` command setting. The default value is `ON`.

`:PLAY:ASI:THROughtout?`

Returns the current throughout mode status when a stream is not output.

`:RECOrd:ASI:THROughtout ON|OFF`

Sets the throughout mode; whether the signal applied to the ASI In connector is output from the ASI Out connector. You can use 1 or 0 instead of `ON` or `OFF`. This setting changes the `:PLAY:ASI:THROughtout` command setting. The default value is `ON`.

`:RECOrd:ASI:THROughtout?`

Returns the current throughout mode status.

Option 02 Universal Parallel/Serial Interface

`:PLAY:UNIVersal:CLOCK RISE|FALL`

Sets the output clock edge of the universal parallel/serial interface. The choices are RISE (rising edge) and FALL (falling edge). The default value is RISE.

`:PLAY:UNIVersal:CLOCK?`

Returns the current output clock edge setting of the universal parallel/serial interface.

`:PLAY:UNIVersal:FORMat PARAllel|SERial`

Sets the output format of the universal parallel/serial interface. The choices are PARAllel and SERial. The default value is PARAllel.

`:PLAY:UNIVersal:FORMat?`

Returns the current output format setting of the universal parallel/serial interface.

`:PLAY:UNIVersal:LEVEl ECL|TTL|LVDS`

Sets the output level of the universal parallel/serial interface. The choices are ECL, TTL, and LVDS. The default value is ECL.

`:PLAY:UNIVersal:LEVEl?`

Returns the current output level setting of the universal parallel/serial interface.

`:RECOrd:UNIVersal:CLOCK RISE|FALL`

Sets the input clock edge of the universal parallel/serial interface. The choices are RISE (rising edge) and FALL (falling edge). This setting changes the `:PLAY:UNIVersal:CLOCK` command setting. The default value is RISE.

`:RECOrd:UNIVersal:CLOCK?`

Returns the current input clock edge setting of the universal parallel/serial interface.

`:RECORD:UNIVERSAL:FORMAT PARALLEL|SERIAL`

Sets the input format of the universal parallel/serial interface. The choices are PARALLEL and SERIAL. This setting changes the `:PLAY:UNIVERSAL:FORMAT` command setting. If the `:RECORD:UNIVERSAL:TERMINATION` command is set to OFF, you cannot set the format to SERIAL. The default value is PARALLEL.

`:RECORD:UNIVERSAL:FORMAT?`

Returns the current input format setting of the universal parallel/serial interface.

`:RECORD:UNIVERSAL:LEVEL ECL|TTL|LVDS`

Sets the input level of the universal parallel/serial interface. The choices are ECL, TTL, and LVDS. This setting changes the `:PLAY:UNIVERSAL:LEVEL` command setting. If the `:RECORD:UNIVERSAL:RECEIVE` command is set to SINGLEEND, you cannot set the level to LVDS. The default value is ECL.

`:RECORD:UNIVERSAL:LEVEL?`

Returns the current input level setting of the universal parallel/serial interface.

`:RECORD:UNIVERSAL:PSYNC ON|OFF`

Sets whether the PSYNC signal is used for serial input. When you select ON, the MSB is determined from the PSYNC signal. When you select OFF, the MSB is determined from the bit pattern of the sync byte. You can use 1 or 0 instead of ON or OFF. The default value is ON.

`:RECORD:UNIVERSAL:PSYNC?`

Returns whether the PSYNC signal is used for serial input.

`:RECORD:UNIVERSAL:RECEIVE SINGLEEND|DIFFERENTIAL`

Sets the input type for the parallel interface mode. The choices are SINGLEEND (single end) and DIFFERENTIAL. If the `:RECORD:UNIVERSAL:LEVEL` command is set to LVDS, or the `:RECORD:UNIVERSAL:TERMINATION` command is set to OFF, you cannot set the input type to SINGLEEND. The default value is SINGLEEND.

`:RECORD:UNIVERSAL:RECEIVE?`

Returns the current input type setting for the parallel interface mode.

`:RECORD:UNIVERSAL:TERMINATION ON|OFF`

Turns on or off the internal termination of the universal parallel/serial interface. You can use 1 or 0 instead of ON or OFF. If the `:RECORD:UNIVERSAL:FORMAT` command is set to SERIAL, or the `:RECORD:UNIVERSAL:RECEIVE` command is set to SINGLEEND, you cannot set the internal termination to OFF. The default value is ON.

`:RECORD:UNIVERSAL:TERMINATION?`

Returns the current internal termination setting of the universal parallel/serial interface.

Option 05 IEEE1394/ASI Interface

`:I1394I:CONNECT <numeric_value>[,<numeric_value>]`

Starts the connection between the MTX100A Option 05 and an IEEE1394 device(s). Specify the node ID of the device(s) in the argument(s). Refer to the `:I1394I:NODE:CATALOG` command. When the `:I1394I:MODE` command is set to PTOPE, specify the destination device. When the `:I1394I:MODE` command is set to PROBE, specify the source and destination devices.

`:I1394I:CONNECT?`

Returns the node ID of the IEEE1394 device(s) currently connected to the MTX100A Option 05.

`:I1394I:DISCONNECT`

Disconnects the IEEE1394 device(s) connected to the MTX100A Option 05.

`:I1394I:MODE PTOPE|PROBE`

Sets the connection mode when using the IEEE1394 interface. The choices are PTOPE (point to point connection) and PROBE (data probing). The default value is PTOPE.

`:I1394I:MODE?`

Returns the current connection mode when using the IEEE1394 interface.

`:I1394I:NODE:CATALOG?`

Lists all the nodes that are connected to the IEEE1394 interface. The response format is as follows:

“node ID, vendor ID, serial number, vendor name, device name”

:I1394I:NODE:ID?

Returns the node information of the MTX100A Option 05. The response format is as follows:

“node ID, vender ID, serial number, vendor name, device name”

The node ID is always 0.

:I1394I:STATus?

Returns the current connection status to an IEEE1394 device. The available responses are:

0: an IEEE1394 device is not connected

1: an IEEE1394 device is connected

:I1394I:TOTUner ON|OFF

Sets whether the connection setting is made by the IEEE1394 device in connecting the MTX100A Option 05 to an IEEE1394 device. You can use 1 or 0 instead of ON or OFF. The default value is OFF.

:I1394I:TOTUner?

Returns whether the connection setting is made by the IEEE1394 device in connecting the MTX100A Option 05 to an IEEE1394 device.

:PLAY:ASI:FORMat BYTE|PACKet

Sets the output format of the ASI signal. The choices are BYTE and PACKet. For BYTE, valid data is output using a burst transmission mode. For PACKet, valid data is output in each transport stream packet. The default value is PACKet.

:PLAY:ASI:FORMat?

Returns the current output format setting of the ASI signal.

:RECORD:I1394I:INPUTport ASI|I1394I

Sets the connector used to capture a stream. The choices are ASI and I1394I (IEEE1394). The default value is I1394I.

:RECORD:I1394I:INPUTport?

Returns the current input connector.

:RECORD:I1394I:PARTIALts ON|OFF

Sets whether the input transport stream is recorded in the partial transport stream format. You can use 1 or 0 instead of ON or OFF. The default value is ON.

:RECORD:I1394I:PARTIALts?

Returns whether the input transport stream is recorded in the partial transport stream format.

Option 07 SMPTE310M/ASI /SPI Interface

:PLAY:ASI:FORMat BYTE|PACKet

Sets the output format of the ASI signal. The choices are BYTE and PACKET. For BYTE, valid data is output using a burst transmission mode. For PACKET, valid data is output in each transport stream packet. The default value is PACKET.

:PLAY:ASI:FORMat?

Returns the current output format setting of the ASI signal.

:PLAY:OP07AS:PORT:TYPE ASI|S310M

Selects which signal to output from the SMPTE310M/ASI Output connector. The choices are ASI and S310M (SMPTE310M). The default value is S310M.

:PLAY:OP07AS:PORT:TYPE?

Returns the current output signal selection.

:RECORD:OP07AS:INPUTport BNC|SPI

Sets the connector used to capture a stream. The choices are BNC (SMPTE310M/ASI Input) and SPI. The default value is BNC.

:RECORD:OP07AS:INPUTport?

Returns the current input connector.

:RECORD:OP07AS:PORT:THROUGHout ON|OFF

Sets the throughout mode; whether the signal applied to the SMPTE310M/ASI Input connector is output from the SMPTE310M/ASI Output connector. You can use 1 or 0 instead of ON or OFF. The default value is ON.

:RECOrd:OP07AS:PORT:THROughout?

Returns the current throughout mode status.

:RECOrd:OP07AS:PORT:TYPE ASI|S310M

Selects the input signal expected from the SMPTE310M/ASI Input connector. The choices are ASI and S310M (SMPTE310M). The default value is S310M.

:RECOrd:OP07AS:PORT:TYPE?

Returns the current input signal selection.

:RECOrd:TIMESamp ON|OFF

Sets whether to enable the timestamp feature. When you select ON, packet arrival time information is stored in each packet in a transport stream. You can use 1 or 0 instead of ON or OFF. The default value is ON.

:RECOrd:TIMESamp?

Returns the current timestamp status.

Default Settings

Table 3-23 lists the default settings of the remote commands.

These default settings can be set by using the *RST command, except for the :SYSTEM:COMMunicate:SOCKET command settings.

Table 3-23: Default Settings

Header	Default settings
DISPLAY commands	
:DISPlay:VIEW:FORMat	HEXadecimal
PLAY commands	
:PLAY:AUTOplay	OFF (0)
:PLAY:CLOCK:DEFault:RATE	5.6610E+001
:PLAY:CLOCKDEFault:RATE:RATIO	629,300
:PLAY:CLOCK:ESRAtfixed	OFF (0)
:PLAY:CLOCKISDBT:CONVert	ON (1)
:PLAY:CLOCK:RATE	5.6610E+001
:PLAY:CLOCK:RATE:RATIO	0, 0
:PLAY:CLOCK:SOURce	INTerna1
:PLAY:EXTerna1	OFF (0)
:PLAY:EXTTrigger:BNC	INPUT
:PLAY:EXTTrigger:OUTPut:DELAy	0
:PLAY:EXTTrigger:OUTPut:SELEct	C27M
:PLAY:LOOP	ON (1)
:PLAY:LOOP:ISDBT:FRAME	ON (1)
:PLAY:PACKet	188
:PLAY:PCR:INACcuracy	NONE
:PLAY:PCR:INITial	0, 0
:PLAY:S192F:PARTialts	ON (1)
:PLAY:SOURce	DISK
:PLAY:SPIOOutput	ON (1)
:PLAY:SSPOsition:INITial:ENABle	ON (1)
:PLAY:SSPOsition:INITial[:POSition]	0
:PLAY:SSPOsition:INITial:TIME	00:00:00
:PLAY:SSPOsition[:POSition]	0, 0
:PLAY:SSPOsition:TIME	00:00:00, 00:00:00
:PLAY:SYNC	TSPAcet
:PLAY:SYNC:DVALid:WIDTh	NONE
:PLAY:SYNC:PSYNc:INTerva1	NONE

Table 3-23: Default Settings (cont.)

Header	Default settings
:PLAY:TIMEpacket:DEFine	Current data and time
:PLAY:TIMEpacket:MODE	ORIGinaL
:PLAY:UPDAte	ON (1)
:PLAY:ITEM:CC	ON (1)
:PLAY:ITEM:NPT	OFF (1)
:PLAY:ITEM:PCR	ON (1)
:PLAY:ITEM:PCR:METHod	HARDware
:PLAY:ITEM:REEDsolomon	ON (1)
:PLAY:ITEM:TIMEpacket	ON (1)
RECORD commands	
:RECORD:EXTERnaL	OFF (0)
:RECORD:SOURce	SPI
:RECORD:STORE:MODE	OVERwrite
:RECORD:TARGET:IGNOredvalid	OFF (0)
:RECORD:TARGET:SIZE	50 [MB}
:RECORD:TARGET:TIME	00:00:00
:RECORD:TARGET:TRIGGER:CONTInuous	OFF (0)
:RECORD:TARGET:TRIGGER:CONTInuous:LIMit	32767
:RECORD:TARGET:TRIGGER:POSItion	0 [%]
:RECORD:TARGET:TYPE	DISK
:RECORD:TARGET:UNLImit	OFF (0)
SYSTEM commands	
:SYSTEM:COMMUnicate:SOCKET:PORT	49152
:SYSTEM:COMMUnicate:SOCKET:RXTERM	LF
:SYSTEM:COMMUnicate:SOCKET:TXTERM	CRLF
:SYSTEM:KLOCK[:STATe]	OFF (0)
:SYSTEM:MODE	PLAY
:SYSTEM:STANDard	ARIB
Optional commands	
Option 01 ASI Interface	
:PLAY:ASI:FORMat	PACKet
:PLAY:ASI:THROUghout	ON (1)
:RECORD:ASI:THROUghout	ON (1)
Option 02 Universal Parallel/Serial Interface	
:PLAY:UNIVersal:CLOCK	RISE
:PLAY:UNIVersal:FORMat	PARAllel
:PLAY:UNIVersal:LEVEl	ECL
:PLAY:UNIVersal:PICLock	1
:RECORD:UNIVersal:CLOCK	RISE

Table 3-23: Default Settings (cont.)

Header	Default settings
:RECORD:UNIVERSAL:FORMAT	PARALLEL
:RECORD:UNIVERSAL:LEVEL	ECL
:RECORD:UNIVERSAL:PSYNC	ON (1)
:RECORD:UNIVERSAL:RECEIVE	SINGLEEND
:RECORD:UNIVERSAL:TERMINATION	ON (1)
Option 05 IEEE1394/ASI Interface	
:I1394I:MODE	PTOP
:I1394I:TOTUNER	OFF (0)
:PLAY:ASI:FORMAT	PACKET
:RECORD:I1394I:INPUTPORT	I1394I
:RECORD:I1394I:PARTIALTS	ON (1)
Option 07 SMPTE310M//ASI/SPI Interface	
:PLAY:ASI:FORMAT	PACKET
:PLAY:OP07AS:PORT:TYPE	S310M
:RECORD:OP07AS:INPUTPORT	BNC
:RECORD:OP07AS:PORT:THROUGHOUT	ON (1)
:RECORD:OP07AS:PORT:TYPE	S310M
:RECORD:TIMESTAMP	ON (1)

Error Message and Codes

This section lists the error messages and codes.

Error messages and codes can be obtained by using the query :SYSTem:ERRor[:NEXT]?. These are returned in the following format:

```
<error_code>,"<error_message>"
```

Command Errors

Command errors are returned when there is a syntax error in the command.

Table 3-24: Command errors

Error code	Error message
-100	command error
-101	invalid character
-102	syntax error
-103	invalid separator
-104	data type error
-105	GET not allowed
-108	parameter not allowed
-109	missing parameter
-110	command header error
-111	header separator error
-112	program mnemonic too long
-113	undefined header
-114	header suffix out of range
-120	numeric data error
-121	invalid character in numeric
-123	exponent too large
-124	too many digits
-128	numeric data not allowed
-130	suffix error
-131	invalid suffix
-134	suffix too long
-138	suffix not allowed
-140	character data error
-141	invalid character data
-144	character data too long

Table 3-24: Command errors (cont.)

Error code	Error message
-148	character data not allowed
-150	string data error
-151	invalid string data
-158	string data not allowed
-160	block data error
-161	invalid block data
-168	block data not allowed
-170	command expression error
-171	invalid expression
-178	expression data not allowed
-180	macro error
-181	invalid outside macro definition
-183	invalid inside macro definition
-184	macro parameter error

Execution Errors

These error codes are returned when an error is detected while a command is being executed.

Table 3-25: Execution errors

Error code	Error message
-200	execution error
-201	invalid while in local
-202	settings lost due to RTL
-210	trigger error
-211	trigger ignored
-212	arm ignored
-213	init ignored
-214	trigger deadlock
-215	arm deadlock
-220	parameter error
-221	settings conflict
-222	data out of range
-223	too much data
-224	illegal parameter value
-225	out of memory
-226	lists not same length

Table 3-25: Execution errors (cont.)

Error code	Error message
-230	data corrupt or stale
-231	data questionable
-240	hardware error
-241	hardware missing
-250	mass storage error
-251	missing mass storage
-252	missing media
-253	corrupt media
-254	media full
-255	directory full
-256	FileName not found
-257	FileName error
-258	media protected
-260	execution expression error
-261	math error in expression
-270	execution macro error
-271	macro syntax error
-272	macro execution error
-273	illegal macro label
-274	execution macro parameter error
-275	macro definition too long
-276	macro recursion error
-277	macro redefinition not allowed
-278	macro header not found
-280	program error
-281	cannot create program
-282	illegal program name
-283	illegal variable name
-284	program currently running
-285	program syntax error
-286	program runtime error

Device Specific Errors

These error codes are returned when an internal instrument error is detected. This type of error may indicate a hardware problem.

Table 3-26: Device specific errors

Error code	Error message
-300	device specific error
-310	system error
-311	memory error
-312	PUD memory lost
-313	calibration memory lost
-314	save/recall memory lost
-315	configuration memory lost
-330	self test failed
-350	queue overflow

Query Errors

These error codes are returned in response to an unanswered query.

Table 3-27: Query errors

Error code	Error message
-400	query error
-410	query interrupted
-420	query unterminated
-430	query deadlocked
-440	query unterminated after indefinite period

Network Interface Specifications

The MTX100A supports remote control using the Ethernet interface. This section describes the MTX100A network interface specifications.

The TCP/IP is used as the network protocol. The commands can be sent from the application program through the socket interface of the TCP/IP. Also, the query can be received through the interface.

Keep the following in mind while controlling the MTX100A remotely with the Ethernet interface.

- The LF (line feed) or CR (carriage return) code is needed at the end of a message as a terminator. Use the Communication dialog box (see Figure 3-9 on page 3-23) or the :SYSTem:COMMunicate:SOCKet:RXTERM command to set which terminator is used.
- The IEEE 488.1 standard (for instance Device Clear or Service Request) is not supported.
- The Message Exchange Control Protocol in the IEEE 488.2 is not supported. However, the common commands such as *ESE and the event handling features are supported.
- The Indefinite format (the block start at #0) in the <ARBITRARY BLOCK PROGRAM DATA> of the IEEE 488.2 is not supported.

Checking Remote Command Operation

To check remote command operation of the MTX100A, perform the following steps:

1. Connect the MTX100A to your PC using an Ethernet cable. Refer to *Connecting to a Network* on page 3-67 for detailed information about how to connect the MTX100A to your PC.
2. Click the Windows **Start** button and select **Run** from the start menu. The Run dialog box appears as shown in Figure 3-34.

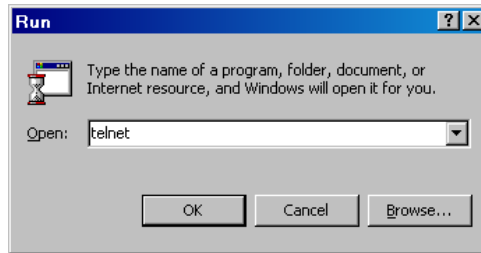

Figure 3-34: Run dialog box

3. In the Open text box, type **telnet** and then click **OK**. The Telnet window appears as shown in Figure 3-35.

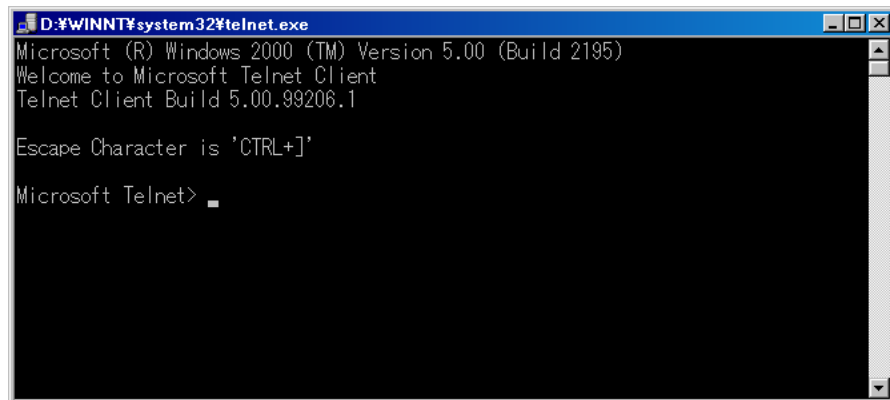

Figure 3-35: Telnet window

4. At the command line prompt, type `set local_echo` and press the **Enter** key. This sets the local echo mode to on.
5. At the command line prompt, type `open <host name> <port number>` and press the **Enter** key.
 where `<host name>` is a computer name of the MTX100A to be connected and `<port number>` is the port number set in the Communication dialog box (default value: 49152).
6. At the command line prompt, type `*IDN?` and press the **Enter** key.
7. Check that the following ID information of the MTX100A appears:
 TEKTRONIX, MTX100A, Vx.xx, Hxx, Cxx

Using the IEEE1394 Interface (Option 05 Only)

The IEEE1394 interface of the MTX100A Option 05 allows you to send and receive a transport stream from an IEEE1394 device, and to capture a transport stream transmitting between two IEEE1394 devices using the following three modes:

- Point-to-point connection
- Data probing
- ASI/IEEE1394 input/output conversion

This section explains how to connect the MTX100A Option 05 and IEEE1394 device(s), and how to set up the MTX100A Option 05 when using these modes.

For this section, you need a keyboard and mouse connected to the MTX100A Option 05.

Refer to *Using the Menu* beginning on page 3-3 for detailed information about menus and dialog boxes related to the IEEE1394 interface settings.

NOTE. *The MTX100A Option 05 does not support the copy protection feature by DTCP (Digital Transmission Control Protection). Therefore, you cannot record or play copy-guarded data using the IEEE1394 interface.*

Note for Connections

When you connect the MTX100A Option 05 to IEEE1394 device(s) such as a BS/CS tuner or a D-VHS recorder, note the following:



CAUTION. *To prevent possible damage to the MTX100A Option 05, do not use a damaged IEEE1394 cable for connection.*

- Connect an IEEE1394 cable to the MTX100A Option 05 after power on. If you power on the instrument with the IEEE1394 cable connected, it takes about 10 to 30 seconds for the instrument to enable the menu operation.
- Power on the MTX100A Option 05 first, and then power on an IEEE1394 device(s).

- The MTX100A Option 05 does not function as a repeater with the instrument powered off. If you make the following connections when the MTX100A Option 05 is powered off, the connection between a BS/CS tuner and a D-VHS recorder is not established.

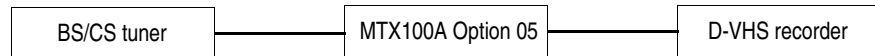

- If you disconnect the power cord from the IEEE1394 device with an IEEE1394 cable connected, the device information displayed on the MTX100A Option 05 may become incorrect.

Point-to-Point Connection

In the point-to-point connection, you can connect the MTX100A Option 05 to an IEEE1394 device such as a BS/CS tuner or a D-VHS recorder, and send and receive a transport stream from the device (see Figure 3-36).

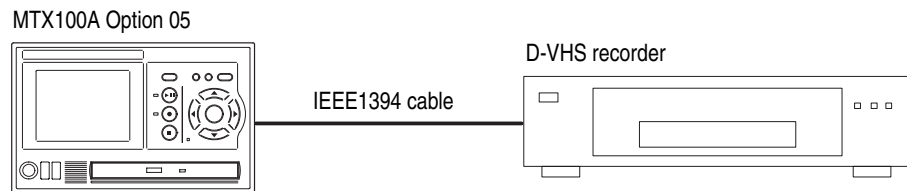

Figure 3-36: Connection example for point-to-point connection

This subsection describes the setting procedure to use the point-to-point connection of the MTX100A Option 05. In the following procedure, you will connect the MTX100A Option 05 to a D-VHS recorder.

Sending a transport stream to the D-VHS Recorder

1. Use an IEEE1394 cable to connect the IEEE1394 connector on the MTX100A Option 05 to the IEEE1394 connector on the D-VHS recorder.
2. In the device connection menu of the D-VHS recorder, select the MTX100A Option 05. Refer to the instruction manual attached with the D-VHS recorder for the device connection menu.
3. Press the **PLAY** button on the MTX100A Option 05 to display the Play screen.
4. Select **PtoP Connect** from the **1394 Mode** command in the **ASI/1394** menu, or click the **PtoP Connect** button on the toolbar. The IEEE1394 dialog box appears.

5. Select the D-VHS recorder from the **Instrument** list box, and then click the **Connect** button. If necessary, check the **to Tuner** check box.

If the connected IEEE1394 device can operate the other device remotely, check the **to Tuner** check box since the connection setting may be made by the IEEE1394 device (the MTX100A Option 05 cannot be operated remotely from the device).

6. Click the **OK** button.
7. Select the **Open** command from the **File** menu to open the **Select File** dialog box.

NOTE. Some devices may require the SI information such as SIT or NIT when decoding the TS file.

8. In the dialog box, select the transport stream file you want to output.
9. Press the **PLAY** button on the MTX100A Option 05 to output the transport stream.
10. If you want to record the transport stream, press the Record button on the D-VHS recorder.

Receiving a transport stream from the D-VHS Recorder

1. Use an IEEE1394 cable to connect the IEEE1394 connector on the MTX100A Option 05 to the IEEE1394 connector on the D-VHS recorder.
2. In the device connection menu of the D-VHS recorder, select the MTX100A Option 05. Refer to the instruction manual attached with the D-VHS recorder for the device connection menu.
3. Press the **REC** button on the MTX100A Option 05 to display the Record screen.
4. Select **ASI/1394** from the **Source** command in the **Record** menu.
5. Select **1394** from the **Input Port** command in the **ASI/1394** menu.
6. Select **PtoP Connect** from **1394 Mode** command in the **ASI/1394** menu, or click the **PtoP Connect** button on the toolbar. The IEEE1394 dialog box appears.
7. Select the D-VHS recorder from the **Instrument** list box, and then click the **Connect** button.
8. Click the **OK** button.
9. Press the Play button on the D-VHS recorder to start playing a transport stream. The hierarchy view of the captured transport stream is displayed on the screen of the MTX100A Option 05.

Recording the Transport Stream.

10. If the transport stream being captured is in the partial transport stream format, select **On** from the **Partial TS** command in the **ASI/1394** menu.

NOTE. Be sure to set the Partial TS command to On when you record a partial transport stream. If you fail to do this, the packet interval does not reproduce correctly while outputting the file. Refer to About the Partial Transport Stream on page for detailed information about the partial transport stream.

11. Press the **REC** button on the MTX100A Option 05 to start recording the transport stream.

Data Probing

In data probing, when the connection between two IEEE1394 devices is established, you can capture the transport stream transmitting between them using the MTX100A Option 05 (see Figure 3-37).

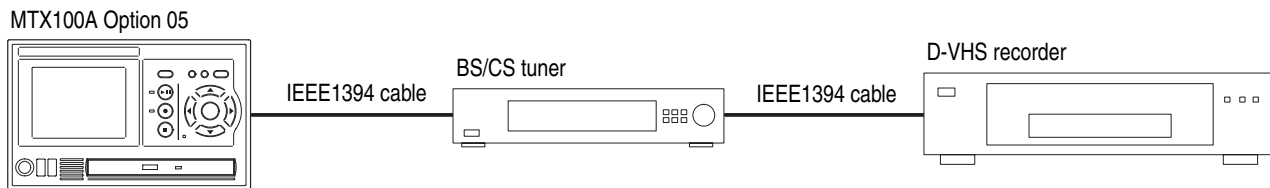

Figure 3-37: Connection example for data probing

This subsection describes the setting procedure to use the data probing of the MTX100A Option 05. In the following procedure, you will connect the MTX100A Option 05 to a BS/CS tuner and connect a BS/CS tuner to a D-VHS recorder.

1. Use an IEEE1394 cable to connect the IEEE1394 connector on the MTX100A Option 05 to the IEEE1394 connector on the BS/CS tuner.
2. Use an IEEE1394 cable to connect the IEEE1394 connector on the BS/CS tuner to the IEEE1394 connector on the D-VHS recorder.
3. In the device connection menu of the BS/CS tuner, select the D-VHS recorder. Refer to the instruction manual attached to the BS/CS tuner for the device connection menu.
4. Press the Play button on the D-VHS recorder, and then check that a picture is played by the BS/CS tuner.
5. Press the **REC** button on the MTX100A Option 05 to display the Record screen.

6. Select **ASI/1394** from the **Source** command in the **Record** menu.
7. Select **1394** from the **Input Port** command in the **ASI/1394** menu.
8. Select **Probe** from the **1394 Mode** command in the **ASI/1394** menu, or click the **Probe** button on the toolbar. The IEEE1394 dialog box appears.
9. Select the D-VHS recorder from the **Source** list box.
10. Select the BS/CS tuner from the **Destination** list box.
11. Click the **OK** button.
12. The hierarchy view of the captured transport stream is displayed on the screen of the MTX100A Option 05.

ASI/IEEE1394 Conversion

In the ASI/IEEE1394 conversion, you can output a transport stream applied to the ASI IN connector from the IEEE1394 connector or output a transport stream applied to the IEEE1394 connector from the ASI connector.

ASI→IEEE1394 Conversion

Perform the following procedure to output a transport stream applied to the ASI connector from the IEEE1394 connector:

In the following procedure, you will apply a transport stream output from an MPEG generator to the MTX100A Option 05, and apply the transport stream output from the MTX100A Option 05 to a D-VHS recorder (see Figure 3-38).

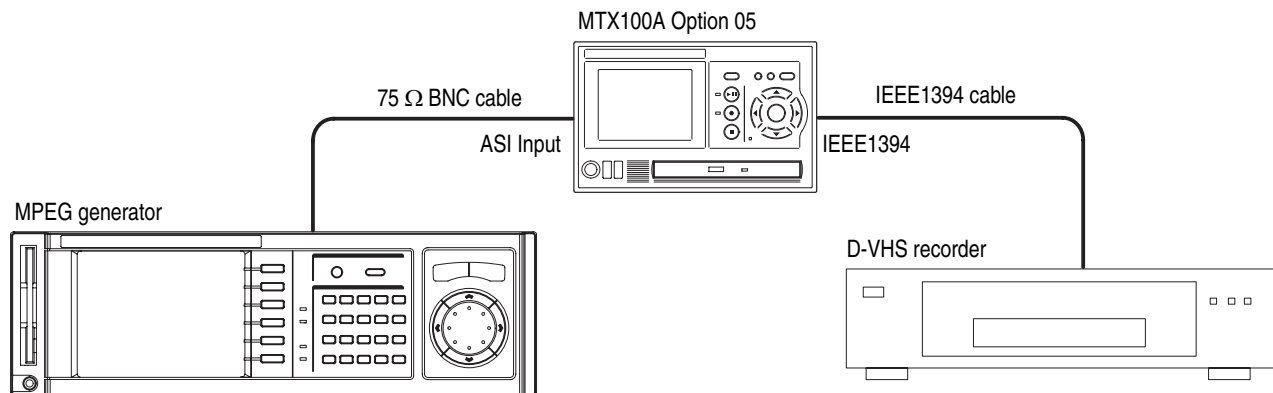

Figure 3-38: Connection example for ASI → IEEE1394 conversion

1. Use a 75 Ω BNC cable to connect ASI OUT connector on the MPEG generator to the ASI Input connector on the MTX100A Option 05.
2. Use an IEEE1394 cable to connect the IEEE1394 connector on the MTX100A Option 05 to the IEEE1394 connector on the D-VHS recorder.
3. In the device connection menu of the D-VHS recorder, select the MTX100A Option 05. Refer to the instruction manual attached with the D-VHS recorder for the device connection menu.
4. Press the **REC** button on the MTX100A Option 05 to display the Record screen.
5. Select **ASI** from the **Input Port** command in the **ASI/1394** menu.
6. Select **PtoP Connect** from the **1394 Mode** command in the **ASI/1394** menu, or click the **PtoP Connect** button on the toolbar. The IEEE1394 dialog box appears.
7. Select the D-VHS recorder from the **Instrument** list box, and then click the **Connect** button. If necessary, check the **to Tuner** check box.
8. Click the **OK** button.

IEEE1394→ASI Conversion

Perform the following procedure to output a transport stream applied to the IEEE1394 connector from the ASI Output connector:

In the following procedure, you will apply a transport stream output from a BS/CS tuner to the MTX100A Option 05, and apply the transport stream output from the MTX100A Option 05 to an MPEG analyzer (see Figure 3-39).

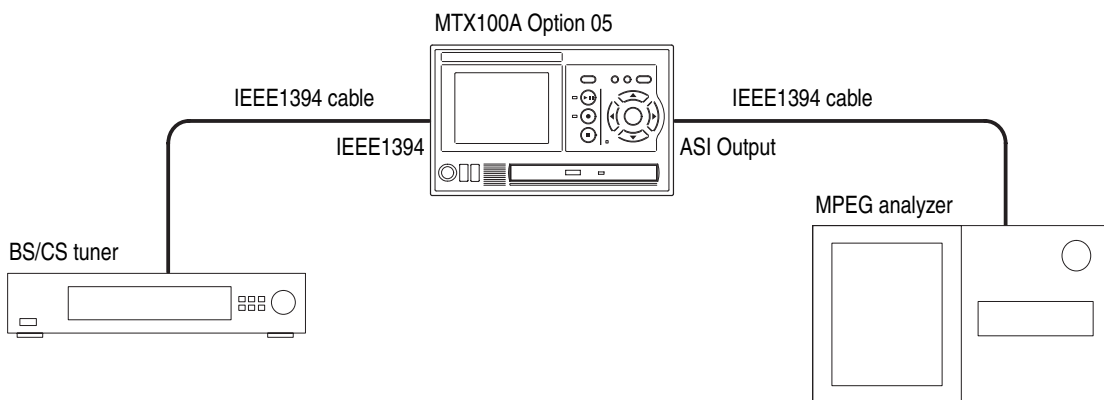

Figure 3-39: Connection example for IEEE1394→ASI conversion

1. Use an IEEE1394 cable to connect the IEEE1394 connector on the BS/CS tuner to the IEEE1394 connector on the MTX100A Option 05.
2. Use a 75 Ω BNC cable to connect ASI Output connector on the MTX100A Option 05 to the ASI IN connector on the MPEG analyzer.
3. In the device connection menu of the BS/CS tuner, select the MTX100A Option 05. Refer to the instruction manual attached to the BS/CS tuner for the device connection menu.
4. Press the **REC** button on the MTX100A Option 05 to display the Record screen.
5. Select **ASI** from the **Input Port** command in the ASI/1394 menu.
6. Select **PtoP Connect** from the **1394 Mode** command in the **ASI/1394** menu, or click the **PtoP Connect** button on the toolbar. The IEEE1394 dialog box appears.
7. Select the BS/CS tuner from the **Instrument** list box, and then click the **Connect** button.
8. Click the **OK** button.

About the Partial Transport Stream

The partial transport stream is a bit stream used for data transmission in IEEE1394 interface. Unlike the MPEG-2 transport stream, the partial transport stream has a time code of 4 bytes after each transport stream packet of 188 bytes (see Figure 3-40). The time code provides the interval between the sync byte of a packet and the sync byte of the next packet in 27 MHz resolution.

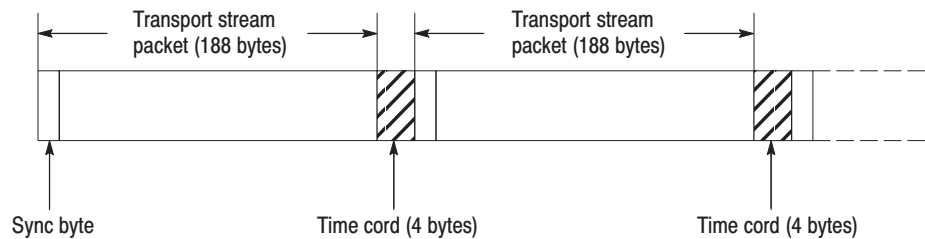

Figure 3-40: Partial transport stream

In the MTX100A Option 05, a captured transport stream can be recorded as a partial transport stream by setting the Partial TS command in the ASI/1394 menu to On.

The packet size of the recorded file in the partial transport stream format is fixed to 192 bytes. When you open the file, the **Partial TS** letters are displayed in the status bar.

The following are notes for recording or playing a partial transport stream:

- Be sure to record a partial transport stream using the partial transport stream format. If you fail to do this, the packet interval is not reproduced when the transport stream is played.
- A partial transport stream with any packet interval more than 600 ms cannot be recorded correctly as a partial transport stream.
- A transport stream cannot be output from the SPI connector while a partial transport stream is played.



Appendices

Appendix A: Specifications

Tables A-1 through A-9 list the functional, electrical, mechanical, and environmental characteristics of the MTX100A. Table A-9 lists the national and international standards to which the MTX100A complies.

All listed specifications are guaranteed unless labeled “typical”. Typical specifications are provided for your convenience but are not guaranteed.

Performance Conditions

The electrical characteristics listed on the following pages are valid under the following conditions:

- The MTX100A must be in an environment where the temperature, altitude, humidity, and vibration conditions are within the operating limits described in Table A-8 on page A-11.
- The MTX100A must have a warm-up period of at least 20 minutes.
- The MTX100A must be operating at an ambient temperature between +5 °C and +40 °C, unless otherwise noted.

Functional Specifications

Table A-1: Functional specifications

Characteristics	Description
System configuration	
System OS	Windows XP Professional
CPU	1.3 GHz
System memory	512 MB
Display	640 x 480 VGA resolution with 256 K colors
Hard disk drive	160 GB
DVD±RW drive	Read and write: DVD+R, DVD+RW, DVD-R, DVD-RW, CD-R, and CD-RW Read only: DVD-ROM and CD-ROM
Expansion slot	1-PCI slot

Electrical Specifications

Table A-2: Mainframe

Characteristics	Description
Maximum output rate	
Hard disk	≥ 120 Mbps
RAM	≥ 200 Mbps
Maximum record rate	
Hard disk	≥ 120 Mbps (File size: < 4 GB, just after disk format operation) ≥ 90 Mbps (File size: 33 GB, just after disk format operation)
RAM	≥ 200 Mbps
Internal reference clock	For Output_clock, PCR/PTS/DTS, Packet operation timing, and TDT/STT time.
Reference clock	27 MHz ± 1 ppm
External reference/clock input	
Connector type	BNC
Input impedance, typical	50 Ω
Reference input	
Frequency	8.129698, 10, 27 MHz
Input level, typical	Sine wave: 0 ± 6 dBm Vp-p Square wave: 0.5 Vp-p to 3.0 Vp-p
Clock input	
Frequency	160 kHz to 26.75 MHz (parallel clock) 1.28 MHz to 32 MHz (serial clock)
Input level, typical	0.5 V to 3.0 V
External trigger input/MISC output	
Connector type	BNC
Input impedance, typical	1 kΩ
Threshold level	Rising and falling edges are programmable
High level	> 3.5 V (maximum input voltage: 7 V)
Low level	< 0.8 V
Output level	
High level	> 2.2 V (with 50 Ω termination)
Low level	< 0.8 V (with 50 Ω termination)
Output impedance	50 Ω
PLL	
Frequency	50 MHz to 100 MHz, locked to reference clock
Output clock	50 MHz maximum (serial clock) 26.75 MHz maximum (parallel clock)
Output rate	214 Mbps maximum 64 Kbps minimum

Table A-2: Mainframe (cont.)

Characteristics	Description																						
TS clock (internal and external reference, 27 and 10 MHz)	TS clock = $(X / (2^Y * Z)) * 27$ MHz $15362 < X < 31248$ $1686 < Y < 3376$ $2 \leq Z \leq 65536$																						
(External parallel clock)	TS clock = $(X / (2^Y * Z)) * \text{external parallel clock}$, 214 MHz maximum $15632 < X < 31248$ $1 < Y < 16383$ $2 \leq Z \leq 65536$																						
(External serial clock)	TS clock = $(X / (2^Y * Z)) * \text{external serial clock} / 8$, 32 MHz maximum $15632 < X < 31248$ $1 < Y < 16383$ $2 \leq Z \leq 65536$																						
P/N and Jitter (serial clock)	< -104 dBc/Hz at 21.455707 MHz + 20 kHz (RBW=300 Hz)																						
SPI interface																							
Connector type	D-sub, 25 pin																						
Data rate	256 Kbps to 214 Mbps																						
Pin assignments	<table border="0"> <tr><td>1</td><td>DCLK</td></tr> <tr><td>2</td><td>GND</td></tr> <tr><td>3 to 10</td><td>DATA 7 to DATA 0</td></tr> <tr><td>11</td><td>DVALID</td></tr> <tr><td>12</td><td>PSYNC</td></tr> <tr><td>13</td><td><u>Shield</u></td></tr> <tr><td>14</td><td>DCLK</td></tr> <tr><td>15</td><td><u>GND</u></td></tr> <tr><td>16 to 23</td><td><u>DATA 7 to DATA 0</u></td></tr> <tr><td>24</td><td><u>DVALID</u></td></tr> <tr><td>25</td><td>PSYNC</td></tr> </table>	1	DCLK	2	GND	3 to 10	DATA 7 to DATA 0	11	DVALID	12	PSYNC	13	<u>Shield</u>	14	DCLK	15	<u>GND</u>	16 to 23	<u>DATA 7 to DATA 0</u>	24	<u>DVALID</u>	25	PSYNC
1	DCLK																						
2	GND																						
3 to 10	DATA 7 to DATA 0																						
11	DVALID																						
12	PSYNC																						
13	<u>Shield</u>																						
14	DCLK																						
15	<u>GND</u>																						
16 to 23	<u>DATA 7 to DATA 0</u>																						
24	<u>DVALID</u>																						
25	PSYNC																						
Output																							
Output level, typical	330 mV to 550 mV (termination: internal 100 Ω , external 100 Ω), bus LVDS with 50 Ω termination																						
Offset	1.1 V to 1.5 V																						
Output resistance, typical	100 Ω , between differential outputs (output off)																						
Data delay, typical	± 5 ns from the falling edge of DCLK (see Figure A-1 on page A-10)																						
Input																							
Input level, typical	> +100 mV, < -100 mV, (RI+)-(RI-) with 100 Ω termination																						
Input resistance, typical	100 Ω (between differential inputs)																						
Clock pulse width, typical	$T/2 \pm T/10$, $T=1/f$ (f=byte clock frequency) (see Figure A-1 on page A-10)																						
Data hold time, typical	$T/2 \pm T/10$, $T=1/f$ (f=byte clock frequency, data are latched on DCLK rising edge) (see Figure A-1 on page A-10)																						
VGA output																							
Connector type	D-sub, 15 pin																						

Table A-2: Mainframe (cont.)

Characteristics	Description																																																				
Pin assignment	<table border="0"> <tr><td>1</td><td>RED</td><td>9</td><td>NC</td></tr> <tr><td>2</td><td>GREEN</td><td>10</td><td>GND</td></tr> <tr><td>3</td><td>BLUE</td><td>11</td><td>NC</td></tr> <tr><td>4</td><td>NC</td><td>12</td><td>NC</td></tr> <tr><td>5</td><td>GND</td><td>13</td><td>HSYNC</td></tr> <tr><td>6</td><td>GND</td><td>14</td><td>YSYNC</td></tr> <tr><td>7</td><td>GND</td><td>15</td><td>NC</td></tr> <tr><td>8</td><td>GND</td><td></td><td></td></tr> </table>	1	RED	9	NC	2	GREEN	10	GND	3	BLUE	11	NC	4	NC	12	NC	5	GND	13	HSYNC	6	GND	14	YSYNC	7	GND	15	NC	8	GND																						
1	RED	9	NC																																																		
2	GREEN	10	GND																																																		
3	BLUE	11	NC																																																		
4	NC	12	NC																																																		
5	GND	13	HSYNC																																																		
6	GND	14	YSYNC																																																		
7	GND	15	NC																																																		
8	GND																																																				
Printer port	Supports SPP (Standard Parallel Port), EPP (Enhanced Parallel Port), and ECP (Extended Capabilities Port) modes.																																																				
Connector type	D-sub, 25 pin																																																				
Pin assignments	<table border="0"> <tr><td>1</td><td>STROBE</td><td>14</td><td>AUTOLF</td></tr> <tr><td>2</td><td>D0</td><td>15</td><td>ERR</td></tr> <tr><td>3</td><td>D1</td><td>16</td><td>INIT</td></tr> <tr><td>4</td><td>D2</td><td>17</td><td>SELECT</td></tr> <tr><td>5</td><td>D3</td><td>18</td><td>GND</td></tr> <tr><td>6</td><td>D4</td><td>19</td><td>GND</td></tr> <tr><td>7</td><td>D5</td><td>20</td><td>GND</td></tr> <tr><td>8</td><td>D6</td><td>21</td><td>GND</td></tr> <tr><td>9</td><td>D7</td><td>22</td><td>GND</td></tr> <tr><td>10</td><td>ACK</td><td>23</td><td>GND</td></tr> <tr><td>11</td><td>BUSY</td><td>24</td><td>GND</td></tr> <tr><td>12</td><td>PaperEmpty</td><td>25</td><td>GND</td></tr> <tr><td>13</td><td>SELECT</td><td></td><td></td></tr> </table>	1	STROBE	14	AUTOLF	2	D0	15	ERR	3	D1	16	INIT	4	D2	17	SELECT	5	D3	18	GND	6	D4	19	GND	7	D5	20	GND	8	D6	21	GND	9	D7	22	GND	10	ACK	23	GND	11	BUSY	24	GND	12	PaperEmpty	25	GND	13	SELECT		
1	STROBE	14	AUTOLF																																																		
2	D0	15	ERR																																																		
3	D1	16	INIT																																																		
4	D2	17	SELECT																																																		
5	D3	18	GND																																																		
6	D4	19	GND																																																		
7	D5	20	GND																																																		
8	D6	21	GND																																																		
9	D7	22	GND																																																		
10	ACK	23	GND																																																		
11	BUSY	24	GND																																																		
12	PaperEmpty	25	GND																																																		
13	SELECT																																																				
USB 2.0 interfaces																																																					
Number of connectors	2																																																				
Pin assignments	<table border="0"> <tr><td>1</td><td>VCC</td><td></td><td></td></tr> <tr><td>2</td><td>-DATA</td><td></td><td></td></tr> <tr><td>3</td><td>+DATA</td><td></td><td></td></tr> <tr><td>4</td><td>GND</td><td></td><td></td></tr> </table>	1	VCC			2	-DATA			3	+DATA			4	GND																																						
1	VCC																																																				
2	-DATA																																																				
3	+DATA																																																				
4	GND																																																				
LAN interface	10/100/1000 Base-T Ethernet interface																																																				
Connector type	RJ-45																																																				
Pin assignment	<table border="0"> <tr><td>1</td><td>MDI_0+</td><td>5</td><td>MDI_2-</td></tr> <tr><td>2</td><td>MDI_0-</td><td>6</td><td>MDI_1-</td></tr> <tr><td>3</td><td>MDI_1+</td><td>7</td><td>MDI_3+</td></tr> <tr><td>4</td><td>MDI_2+</td><td>8</td><td>MDI_3-</td></tr> </table>	1	MDI_0+	5	MDI_2-	2	MDI_0-	6	MDI_1-	3	MDI_1+	7	MDI_3+	4	MDI_2+	8	MDI_3-																																				
1	MDI_0+	5	MDI_2-																																																		
2	MDI_0-	6	MDI_1-																																																		
3	MDI_1+	7	MDI_3+																																																		
4	MDI_2+	8	MDI_3-																																																		
Serial interface (Com)	RS-232C																																																				
Connector type	D-sub, 9 pin																																																				
Pin assignment	<table border="0"> <tr><td>1</td><td>DCD</td><td>6</td><td>DSR</td></tr> <tr><td>2</td><td>RX</td><td>7</td><td>RTS</td></tr> <tr><td>3</td><td>TX</td><td>8</td><td>CTS</td></tr> <tr><td>4</td><td>DTR</td><td>9</td><td>RI</td></tr> <tr><td>5</td><td>GND</td><td></td><td></td></tr> </table>	1	DCD	6	DSR	2	RX	7	RTS	3	TX	8	CTS	4	DTR	9	RI	5	GND																																		
1	DCD	6	DSR																																																		
2	RX	7	RTS																																																		
3	TX	8	CTS																																																		
4	DTR	9	RI																																																		
5	GND																																																				

Table A-2: Mainframe (cont.)

Characteristics	Description																				
IEEE1394b interface																					
Compliant	IEEE1394b-2002																				
Pin assignment	<table border="0"> <tr> <td>1</td> <td>TPB-</td> <td>6</td> <td>VG</td> </tr> <tr> <td>2</td> <td>TPB+</td> <td>7</td> <td>NC</td> </tr> <tr> <td>3</td> <td>TPA-</td> <td>8</td> <td>VP</td> </tr> <tr> <td>4</td> <td>TPA+</td> <td>9</td> <td>TPB (R)</td> </tr> <tr> <td>5</td> <td>TPA (R)</td> <td></td> <td></td> </tr> </table>	1	TPB-	6	VG	2	TPB+	7	NC	3	TPA-	8	VP	4	TPA+	9	TPB (R)	5	TPA (R)		
1	TPB-	6	VG																		
2	TPB+	7	NC																		
3	TPA-	8	VP																		
4	TPA+	9	TPB (R)																		
5	TPA (R)																				
AC line power																					
Rating voltage	100 V to 240 VAC, CATII																				
Voltage range	90 V to 250 VAC																				
Frequency range	50 Hz to 60 Hz																				
Maximum power	180 VA																				
Maximum current	1.3 A																				
Main fuse data	5A Time-delayed, 250 V (not operator replaceable) 2A Time-delayed, 250 V (not operator replaceable)																				

Table A-3: ASI interface (Option 01)

Characteristics	
Standard conformance	EN 50083-9 Annex B
Connector type	BNC
Impedance, typical	75 Ω
Data rate	256 Kbps to 214 Mbps
Output	
Number of outputs	2
Output voltage	800 mV \pm 10%
Jitter	\leq 0.2 UI p-p
Rise/fall time (20% to 80%)	\leq 1.2 ns
Return loss	< -17 dB (5 MHz to 270 MHz) into 75 Ω load
Input	
Number of inputs	1 (with active loop-through output)
Input voltage	200 mV to 800 mV
Return loss	< -17 dB (5 MHz to 270 MHz) into 75 Ω load
Data format	Accepts both burst and packet modes ASI.

Table A-4: Universal parallel/serial interface (Option 02)

Characteristics	Description																						
Parallel interface mode																							
Connector type	D-sub, 25 pin (uses a common connector with the Serial interface.)																						
Data rate	256 Kbps to 214 Mbps																						
Pin assignment	<table> <tr><td>1</td><td>DCLK</td></tr> <tr><td>2</td><td>GND</td></tr> <tr><td>3 to 10</td><td>DATA 7 to DATA 0</td></tr> <tr><td>11</td><td>DVALID</td></tr> <tr><td>12</td><td>PSYNC</td></tr> <tr><td>13</td><td><u>Shield</u></td></tr> <tr><td>14</td><td>DCLK</td></tr> <tr><td>15</td><td><u>GND</u></td></tr> <tr><td>16 to 23</td><td><u>DATA 7 to DATA 0</u></td></tr> <tr><td>24</td><td><u>DVALID</u></td></tr> <tr><td>25</td><td>PSYNC</td></tr> </table>	1	DCLK	2	GND	3 to 10	DATA 7 to DATA 0	11	DVALID	12	PSYNC	13	<u>Shield</u>	14	DCLK	15	<u>GND</u>	16 to 23	<u>DATA 7 to DATA 0</u>	24	<u>DVALID</u>	25	PSYNC
1	DCLK																						
2	GND																						
3 to 10	DATA 7 to DATA 0																						
11	DVALID																						
12	PSYNC																						
13	<u>Shield</u>																						
14	DCLK																						
15	<u>GND</u>																						
16 to 23	<u>DATA 7 to DATA 0</u>																						
24	<u>DVALID</u>																						
25	PSYNC																						
Output level, typical	Note: Do not connect the Asserted Low pins for single-end use.																						
TTL without termination	LO: 0V HI: 3.3 V																						
LVDS without termination	0.66 Vp-p to 1.1 Vp-p (amplitude) 1.1 V to 1.5 V (offset)																						
ECL without termination	LO: -2.1 V HI: -0.5 V																						
Output impedance, typical	50 Ω ± 5% (per pin, single-end)																						
Output resistance, typical	≥ 1 kΩ (when the output is off, per pin, single-end)																						
Data delay, typical	0 ± 5 ns from the falling or rising edge of DCLK (see Figure A-1 on page A-10)																						
Single-end input level, typical																							
TTL with termination	LO: 0.0 V to 0.5 V HI: 1.2 V to 5.0 V																						
ECL with termination	LO: -5.2 V to -1.05 V HI: -0.25 V to 0.0 V																						
Differential input level, typical	0.4 V to 1.0 Vp-p (between +pin and -pin without termination) 0.2 V to 1.0 Vp-p (between +pin and -pin with termination)																						
Input resistance, typical	50 Ω ± 5% (Single End Termination: ON) 110 Ω ± 5% (Differential Termination: ON) ≥ 1 kΩ to GND (Termination: OFF)																						
Clock pulse width, typical	T/2 ± T/10, T=1/f (f=byte clock frequency) (see Figure A-1 on page A-10)																						
Data hold time, typical	T/2 ± T/10, T=1/f (f=byte clock frequency: Data are latched on DCLK rising or falling edge.) (see Figure A-1 on page A-10)																						
Serial interface mode																							
Connector type	D-sub, 25 pin (uses a common connector with the Parallel interface.)																						
Data rate	256 Kbps to 40 Mbps																						

Table A-4: Universal parallel/serial interface (Option 02) (cont.)

Characteristics	Description
Pin assignment	1 DCLK 2 GND 3 to 9 Not managed 10 DATA 0 11 DVALID 12 PSYNC 13 Shield 14 DCLK 15 GND 16 to 22 Not managed 23 DATA 0 24 DVALID 25 PSYNC
Output level, typical	Note: Do not connect the Asserted Low pins for single-end use.
TTL without termination	LO: 0 V HI: 3.3 V
LVDS without termination	0.66 Vp-p to 1.1 Vp-p (amplitude) 1.1 V to 1.5 V (offset)
ECL without termination	LO: -2.1 V HI: -0.5 V
Output impedance, typical	50 Ω \pm 5% (per pin, single-end)
Output resistance, typical	\geq 1 k Ω (when the output is off, per pin, single-end)
Data delay, typical	0 \pm 5 ns from the falling or rising edge of DCLK (see Figure A-1 on page A-10)
Single-end input level, typical	
TTL with termination	LO: 0.0 V to 0.5 V HI: 1.2 V to 5.0 V
ECL with termination	LO: -5.2 V to -1.05 V HI: -0.25 V to 0.0 V
Differential input level, typical	0.4 V to 1.0 Vp-p (between +pin and -pin without termination) 0.2 V to 1.0 Vp-p (between +pin and -pin with termination)
Input resistance, typical	50 Ω \pm 5% (Single End Termination: ON) 110 Ω \pm 5% (Differential Termination: ON) \geq 1 k Ω to GND (Termination: OFF)
Clock pulse width, typical	T/2 \pm T/10, T=1/f (f=byte clock frequency) (see Figure A-1 on page A-10)
Data hold time, typical	T/2 \pm T/10, T=1/f (f=byte clock frequency: Data are latched on DCLK rising or falling edge.) (see Figure A-1 on page A-10)
Event output (EVENT OUT)	
Connector type	BNC
Output level, typical	TTL without termination LO: < 0.4 V HI: > 2.4 V
Output impedance, typical	50 Ω

Table A-5: IEEE1394/ASI interface (Option 05)

Characteristics	Description
IEEE1394 interface	
Standard conformance	IEEE Std 1394-1995 TEEE Standard for High Performance serial Bus
Number of connectors	2
Serial interface rate	S-400
Maximum TS rate	40 Mbps
ASI interface	
Standard conformance	EN 50083-9 Annex B
Connector type	BNC
Impedance, typical	75 Ω
Data rate	256 Kbps to 214 Mbps
Input voltage, typical	200 mV to 800 mV
Output voltage	800 mV \pm 10%
Return loss	< -17 dB (5 MHz to 270 MHz) into 75 Ω load

Table A-6: SMPTE310M/ASI/SPI interface (Option 07)

Characteristics	Description
SMPTE310M interface	Uses common input/output connectors with the ASI interface.
Standard conformance	SMPTE310M
Connector type	BNC
Impedance	75 Ω
Data rate	19.392658 Mbps (8 VSB, 188 bytes packet size)
Output	
Number of outputs	1
Output voltage	800 mV \pm 10%
Jitter	\leq 0.2 UI p-p
Rise/fall time	0.4 ns to 5.0 ns (20% to 80%)
Frequency range, typical	\pm 3%
Input	
Number of inputs	1
Input voltage, typical	800 mV \pm 10%
Frequency range, typical	\pm 3%

Table A-6: SMPTE310M/ASI/SPI interface (Option 07) (cont.)

Characteristics	Description																						
ASI interface	Uses common input/output connectors with the SMPTE310M interface.																						
Standard conformance	EN 50083-9 Annex B																						
Connector type	BNC																						
Impedance	75 Ω																						
Data rate	256 Kbps to 214 Mbps																						
Output																							
Number of outputs	1																						
Output voltage	800 mV \pm 10%																						
Jitter	\leq 0.2 UI p-p																						
Rise/fall time	\leq 1.2 ns																						
Return loss	< -17 dB (5 MHz to 270 MHz) into 75 Ω load																						
Input																							
Number of inputs	1																						
Input voltage, typical	200 mV to 800 mV																						
Return loss	< -17 dB (5 MHz to 270 MHz) into 75 Ω load																						
Data format	Accepts both burst and packet modes ASI.																						
SPI interface																							
Connector type	D-sub, 25 pin																						
Data rate	256 Kbps to 214 Mbps																						
Pin assignments	<table border="0"> <tr><td>1</td><td>DCLK</td></tr> <tr><td>2</td><td>GND</td></tr> <tr><td>3 to 10</td><td>DATA 7 to DATA 0</td></tr> <tr><td>11</td><td>DVALID</td></tr> <tr><td>12</td><td>PSYNC</td></tr> <tr><td>13</td><td>Shield</td></tr> <tr><td>14</td><td>$\overline{\text{DCLK}}$</td></tr> <tr><td>15</td><td>GND</td></tr> <tr><td>16 to 23</td><td>$\overline{\text{DATA 7}}$ to $\overline{\text{DATA 0}}$</td></tr> <tr><td>24</td><td>$\overline{\text{DVALID}}$</td></tr> <tr><td>25</td><td>$\overline{\text{PSYNC}}$</td></tr> </table>	1	DCLK	2	GND	3 to 10	DATA 7 to DATA 0	11	DVALID	12	PSYNC	13	Shield	14	$\overline{\text{DCLK}}$	15	GND	16 to 23	$\overline{\text{DATA 7}}$ to $\overline{\text{DATA 0}}$	24	$\overline{\text{DVALID}}$	25	$\overline{\text{PSYNC}}$
1	DCLK																						
2	GND																						
3 to 10	DATA 7 to DATA 0																						
11	DVALID																						
12	PSYNC																						
13	Shield																						
14	$\overline{\text{DCLK}}$																						
15	GND																						
16 to 23	$\overline{\text{DATA 7}}$ to $\overline{\text{DATA 0}}$																						
24	$\overline{\text{DVALID}}$																						
25	$\overline{\text{PSYNC}}$																						
Input																							
Input level, typical	> +100 mV, < -100 mV, (RI+)-(RI-) with 100 Ω termination																						
Input resistance, typical	100 Ω (between differential inputs)																						
Clock pulse width, typical	$T/2 \pm T/10$, $T=1/f$ (f =byte clock frequency) (see Figure A-1 on page A-10)																						
Data hold time, typical	$T/2 \pm T/10$, $T=1/f$ (f =byte clock frequency, data are latched on DCLK rising edge) (see Figure A-1 on page A-10)																						

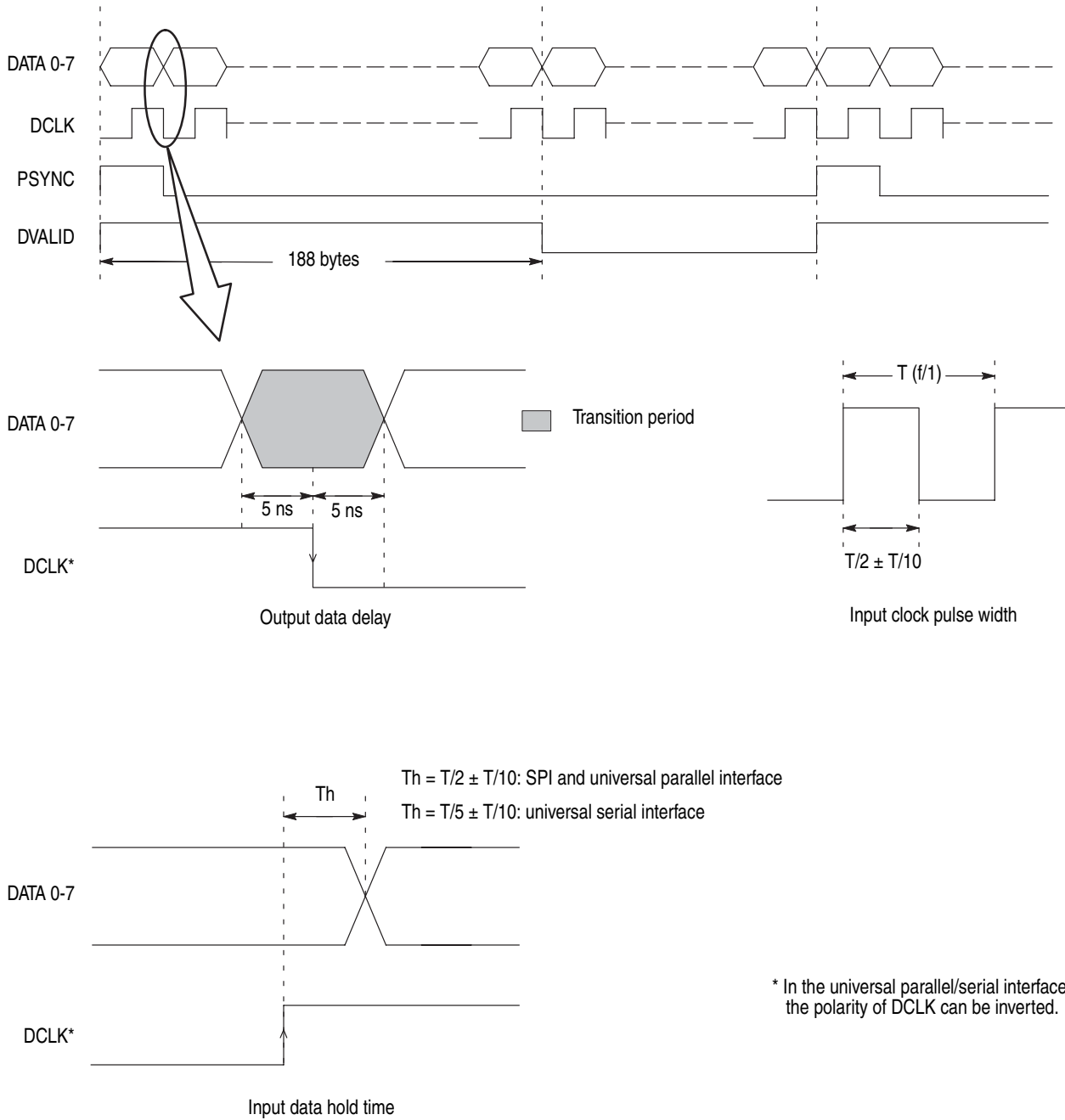

Figure A-1: Timing diagram of the SPI and universal parallel/serial interfaces

Mechanical (Physical) Characteristics

Table A-7: Mechanical characteristics

Characteristics	Description
Net weight	
Standard	Approximately 6 kg
Dimensions	
Height	132 mm (without feet)
Width	214 mm
Length	435 mm

Environmental Characteristics

Table A-8: Environmental characteristics

Characteristics	Description
Temperature	
Operating	+5 °C to +40 °C
Non-operating	-20 °C to +60 °C
Relative humidity	
Operating	20% to 80% (no condensation) Maximum wet-bulb temperature 29.0 °C
Non-operating	5% to 90% (no condensation) Maximum wet-bulb temperature 29.0 °C
Altitude	
Operating	Up to 3.0 km (10,000 feet). Maximum operating temperature decreases 1 °C each 300 m above 1.5 km.
Non-operating	Up to 12 km (40,000 feet)
Dynamics	
Vibration	
Operating	2.65 m/s ² rms (0.27 Grms), 5 Hz to 500 Hz, 10 min, three axes
Non-operating	22.3 m/s ² rms (2.28 Grms), 5 Hz to 500 Hz, 10 min, three axes
Shock	
Non-operating	294 m/s ² (30 G), half-sine, 11 ms duration.

Table A-8: Environmental characteristics (cont.)

Characteristics	Description
Installation requirements	
Power dissipation	100 W maximum. Maximum line current is 1.3 Arms at 50 Hz.
Surge current	≤ 12 A peak for less than 5 line cycles at 25 °C after product has been off for at least 30 seconds.
Cooling clearance	
Top clearance	5 cm
Side clearance	5 cm
Rear clearance	5 cm (from the fan guard)

Certifications and Compliances

Table A-9: Certifications and compliances

Category	Standards or description																		
EC Declarations of Conformity	<p>Meets the intent of Directive 89/336/EEC for Electromagnetic Compatibility. Compliance was demonstrated to the following specifications as listed in the Official Journal of the European Communities:</p> <p>EMC Directive 89/336/EEC:</p> <table border="0"> <tr> <td>EN 55011</td> <td>EMC requirement for Class A electrical equipment for measurement, control and laboratory use.</td> </tr> <tr> <td>EN 61000-3-2</td> <td>AC Power Line Harmonic Emissions</td> </tr> <tr> <td>IEC 61000-4-2</td> <td>Electrostatic Discharge Immunity (Performance Criterion B)</td> </tr> <tr> <td>IEC 61000-4-3</td> <td>RF Electromagnetic Field Immunity (Performance Criterion A)</td> </tr> <tr> <td>IEC 61000-4-4</td> <td>Electrical Fast Transient / Burst Immunity (Performance Criterion B)</td> </tr> <tr> <td>IEC 61000-4-5</td> <td>Power Line Surge Immunity (Performance Criterion B)</td> </tr> <tr> <td>IEC 61000-4-6</td> <td>Conducted RF Immunity (Performance Criterion A)</td> </tr> <tr> <td>IEC 61000-4-11</td> <td>Voltage Dips and Interruptions Immunity (Performance Criterion B)</td> </tr> </table> <p>Low Voltage Directive 73/23/EEC: Amended by 93/68/EEC:</p> <table border="0"> <tr> <td>EN 61010-1: 2001</td> <td>Safety Requirements for Electrical Equipment for Measurement, Control, and Laboratory Use.</td> </tr> </table>	EN 55011	EMC requirement for Class A electrical equipment for measurement, control and laboratory use.	EN 61000-3-2	AC Power Line Harmonic Emissions	IEC 61000-4-2	Electrostatic Discharge Immunity (Performance Criterion B)	IEC 61000-4-3	RF Electromagnetic Field Immunity (Performance Criterion A)	IEC 61000-4-4	Electrical Fast Transient / Burst Immunity (Performance Criterion B)	IEC 61000-4-5	Power Line Surge Immunity (Performance Criterion B)	IEC 61000-4-6	Conducted RF Immunity (Performance Criterion A)	IEC 61000-4-11	Voltage Dips and Interruptions Immunity (Performance Criterion B)	EN 61010-1: 2001	Safety Requirements for Electrical Equipment for Measurement, Control, and Laboratory Use.
EN 55011	EMC requirement for Class A electrical equipment for measurement, control and laboratory use.																		
EN 61000-3-2	AC Power Line Harmonic Emissions																		
IEC 61000-4-2	Electrostatic Discharge Immunity (Performance Criterion B)																		
IEC 61000-4-3	RF Electromagnetic Field Immunity (Performance Criterion A)																		
IEC 61000-4-4	Electrical Fast Transient / Burst Immunity (Performance Criterion B)																		
IEC 61000-4-5	Power Line Surge Immunity (Performance Criterion B)																		
IEC 61000-4-6	Conducted RF Immunity (Performance Criterion A)																		
IEC 61000-4-11	Voltage Dips and Interruptions Immunity (Performance Criterion B)																		
EN 61010-1: 2001	Safety Requirements for Electrical Equipment for Measurement, Control, and Laboratory Use.																		
Australia/New Zealand Declaration of Conformity-EMC	<p>Complies with EMC provision of Radio Communications Act per the following standard(s):</p> <table border="0"> <tr> <td>AS/NZS 2064.1/2</td> <td>Industrial, Scientific, and Medical Equipment: 1992</td> </tr> </table>	AS/NZS 2064.1/2	Industrial, Scientific, and Medical Equipment: 1992																
AS/NZS 2064.1/2	Industrial, Scientific, and Medical Equipment: 1992																		

Table A-9: Certifications and compliances (cont.)

Category	Standards or description
Safety	<p>Complies with the following safety standards/regulations:</p> <p>UL61010-1 Standard for Electrical Measuring and Test Equipment.</p> <p>CAN/CSA C22.2 No.61010-1-04 Safety Requirements for Electrical Equipment for Measurement, Control, and Laboratory Use.</p> <p>EN 61010-1: 2001 Safety Requirements for Electrical Equipment for Measurement, Control, and Laboratory Use.</p>
Installation (Overvoltage) Category Descriptions	<p>Terminals on this product may have different installation (overvoltage) category designations. The installation categories are:</p> <p>CAT III Distribution-level mains (usually permanently connected). Equipment at this level is typically in a fixed industrial location.</p> <p>CAT II Local-level mains (wall sockets). Equipment at this level includes appliances, portable tools, and similar products. Equipment is usually cord-connected.</p> <p>CAT I Secondary (signal level) or battery operated circuits of electronic equipment.</p>
Overvoltage Category	Overvoltage Category II (as defined in IEC 61010-1)
Pollution Degree Descriptions	<p>A measure of the contaminates that could occur in the environment around and within a product. Typically the internal environment inside a product is considered to be the same as the external. Products should be used only in the environment for which they are rated.</p> <p>Pollution Degree 1 No pollution or only dry, nonconductive pollution occurs. Products in this category are generally encapsulated, hermetically sealed, or located in clean rooms.</p> <p>Pollution Degree 2 Normally only dry, nonconductive pollution occurs. Occasionally a temporary conductivity that is caused by condensation must be expected. This location is a typical office/home environment. Temporary condensation occurs only when the product is out of service.</p> <p>Pollution Degree 3 Conductive pollution, or dry, nonconductive pollution that becomes conductive due to condensation. These are sheltered locations where neither temperature nor humidity is controlled. The area is protected from direct sunshine, rain, or direct wind.</p>
Pollution Degree	Pollution Degree 2 (as defined in IEC 61010-1). Note: Rated for indoor use only.
IEC Characteristics	<p>Equipment type:</p> <p>Test and Measuring</p> <p>Safety Class 1 – grounded product</p>

Appendix B: Using the ReMux Application

ReMux provides the capability to create a transport stream of super frame structure defined in the ISDB-S system from an MPEG2 transport stream.

This appendix describes the functions of the ReMux application and shows how to create a transport stream of super frame structure.

NOTE. *The ReMux application cannot handle files larger than 2 GB.*

Starting and Exiting ReMux

The ReMux application is preinstalled on the MTX100A. To start the ReMux application, select **Tektronix > MPEG > ReMux** from the Start -Programs menu on the Windows desktop.

If you create a shortcut icon of the Remux application on the Windows desktop, you can start the ReMux application by double-clicking it. Refer to the Windows help for information about how to create a shortcut icon.

To exit (quit) the ReMux application, select **Exit** from the application **File** menu.

Elements of the ReMux Window

Figure B-1 shows the ReMux application window. Table B-1 describes the elements in the application window.

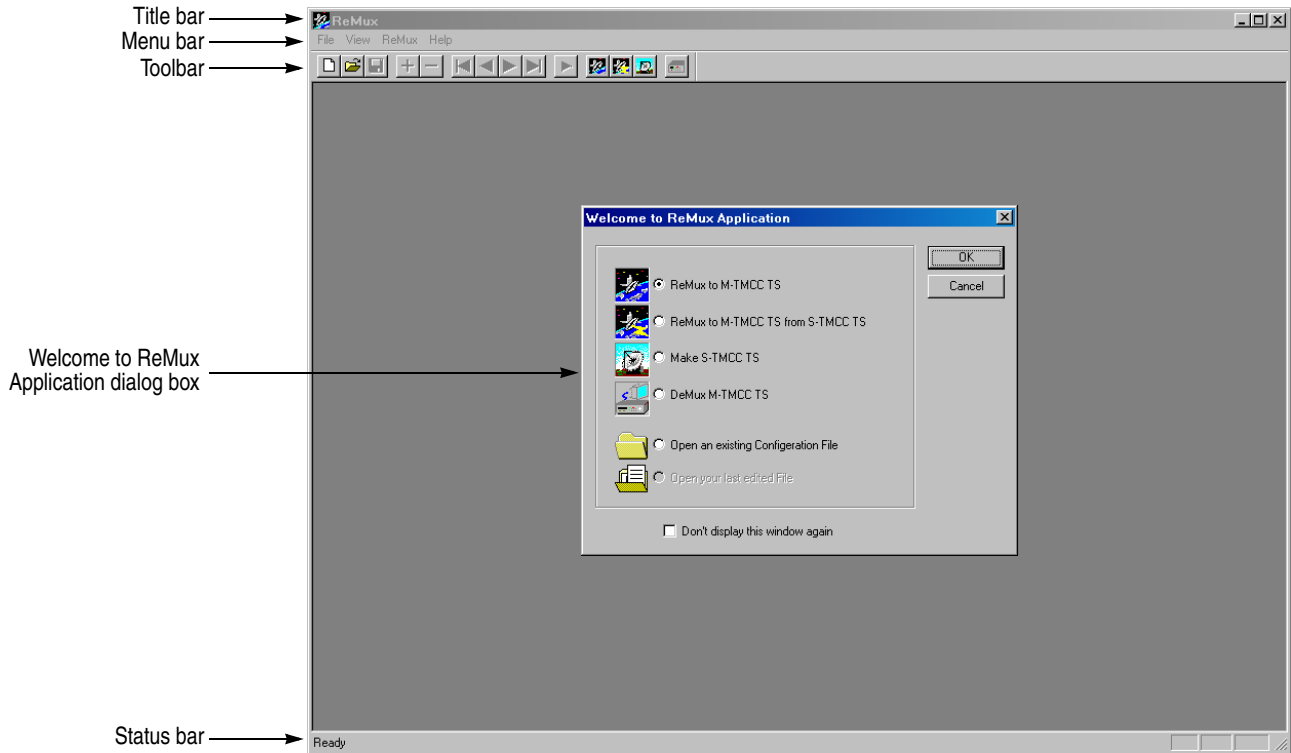















Figure B-1: ReMux application window

Table B-1: Element of the ReMux window

Element	Description
Title bar	The Title bar displays the name of the application and contains the standard window-sizing boxes for Windows.
Menu bar	The Menu bar displays the names of the six pull-down menus. Refer to <i>Using the ReMux Menus</i> on page B-5 for detailed information about the functions available in the menus.
Toolbar	The toolbar provides shortcut buttons for many of the most often used menu commands. Click a toolbar button to select the corresponding command. You can toggle the toolbar display on and off using the Toolbar command in the View pull-down menu. Table B-2 describes the function of each toolbar button.
Welcome to ReMux Application dialog box	<p>Use this dialog box to select the operation mode.</p> <ul style="list-style-type: none"> ● ReMux to M-TMCC TS: Create a transport stream of M-TMCC structure from a transport stream. ● ReMux to M-TMCC TS from S-TMCC TS: Create a transport stream of M-TMCC structure from a transport stream of S-TMCC structure. ● Make S-TMCC TS: Creates a transport stream of S-TMCC structure from a transport stream. ● DeMux M-TMCC TS: De-multiplexes (separates) the original transport stream from a transport stream of M-TMCC structure. ● Open an existing Configuration File: Opens a stored configuration file (.cfg). ● Open your last edited File: Opens the file used last (configuration file or transport stream file). <p>You can toggle the dialog box display on or off using the OPTION dialog box. Refer to <i>OPTION Dialog Box</i> on page B-7 for detailed information about the dialog box.</p>
Status bar	The status bar displays the short explanation of the currently selected command and information related to the operation. You can toggle the status bar display on and off using the Status Bar command in the View pull-down menu.

Table B-2: Toolbar button descriptions

Icon	Name	Function
	New	Equivalent to the New command in the File menu.
	Open	Equivalent to the Open command in the File menu.
	Save	Equivalent to the Save command in the File menu.
	Add	Equivalent to the Add command in the Edit menu.
	Delete	Equivalent to the Delete command in the Edit menu.
	First	Equivalent to the First command in the Edit menu.
	Previous	Equivalent to the Previous command in the Edit menu.
	Next	Equivalent to the Next command in the Edit menu.
	Last	Equivalent to the Last command in the Edit menu.
	Execute	Equivalent to the Execute command in the ReMux menu.
	ReMux to M-TMCC TS	Equivalent to the Mode: ReMux to M-TMCC TS command in the ReMux menu.
	ReMux to M-TMCC TS from S-TMCC TS	Equivalent to the Mode: ReMux to M-TMCC TS from S-TMCC TS command in the ReMux menu.
	Make S-TMCC TS	Equivalent to the Mode: Make S-TMCC TS command in the ReMux menu.
	DeMux to M-TMCC TS	Equivalent to the Mode: DeMux to M-TMCC TS command in the ReMux menu.

Using the ReMux Menus

The Menu bar has six pull-down menus: File, Edit, View, ReMux, Window, and Help. This section describes the function of each selection in these menus.

File Menu The File menu contains commands for managing file operations and for exiting the ReMux application. Table B-3 describes each of the File menu commands.

Table B-3: ReMux File menu commands

Command	Function
New	Opens the Select Remux Mode dialog box where you can select the mode to execute. Refer to <i>Select Remux Mode Dialog Box</i> on page B-5 for detailed information about the dialog box parameters.
Open	Opens a saved configuration file or a transport stream file of M-TMCC structure. If you try to open other files, an error message appears.
Close	Closes the active window.
Save	Saves the active window settings to a configuration file.
Save as	Saves the active window settings to the specified configuration file.
Exit	Exits the ReMux application.

Select Remux Mode Dialog Box. The Select Remux Mode dialog box (see Figure B-2) appears after you select the New command in the File menu. Select one of the ReMux modes, then click the **OK** button. Table B-4 describes the Select Remux Mode dialog box parameters.

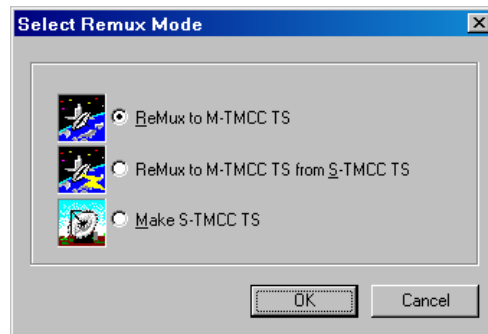

Figure B-2: Select Remux Mode dialog box

- **ReMux to M-TMCC TS:** Creates a transport stream of M-TMCC structure from a transport stream.
- **ReMux to M-TMCC TS from S-TMCC TS:** Creates a transport stream of M-TMCC structure from a transport stream of S-TMCC structure.
- **Make S-TMCC TS:** Creates a transport stream of S-TMCC structure from a transport stream.

Edit Menu

The Edit menu contains commands that control TMCC information display and add/delete TMCC information and transport stream. Table B-5 describes each of the Edit menu commands.

Table B-4: ReMux File menu commands

Command	Function
Previous	Displays the previous TMCC information.
Next	Displays the next TMCC information.
First	Displays the first TMCC information.
Last	Displays the last TMCC information.
Add	Adds TMCC information or a transport stream.
Delete	Deletes TMCC information or a transport stream.

ReMux Menu

The ReMux menu contains commands that execute the selected operation, select a ReMux mode, and select option settings. Table B-6 describes each of the ReMux menu commands.

Table B-5: ReMux menu commands

Command	Function
Execute	Executes the ReMux or DeMux operation.
Mode	Selects a ReMux mode. This command has the same function as the New command in the File menu.
Option	Opens the OPTION dialog box where you can set the TS ID of the transport stream(s) inserted as a dummy and toggle the Welcome dialog box display on or off. Refer to <i>OPTION Dialog Box</i> on page B-7 for detailed information about the dialog box parameters.

OPTION Dialog Box. The OPTION dialog box (see Figure B-3) appears after you select the Option command in the ReMux menu.

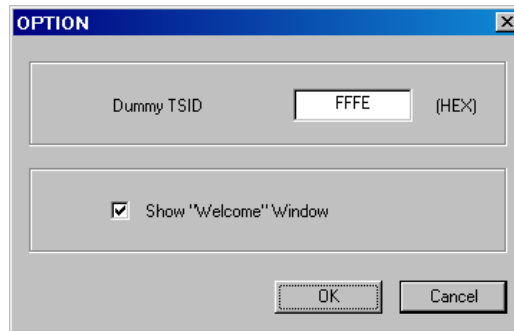

Figure B-3: OPTION dialog box

In the dialog box, you can set the following parameters:

- **Dummy TSID:** When you select ReMux to M-TMCC TS or ReMux to M-TMCC TS from S-TMCC mode, if the number of slots of the transport stream of M-TMCC structure is less than 48, dummy transport streams are inserted automatically so that the number of slots is equal to 48. This parameter sets the transport stream ID for all of them.
- **Show “Welcome” Window:** Sets whether or not the Welcome to ReMux Application dialog box appears when you start the ReMux application.

Window Menu

The Window menu contains commands that control the appearance of the editing windows and open the new window. Table B-6 describes each of the Window menu commands.

Table B-6: ReMux Window menu commands

Command	Function
New Window	Opens the new window with the same settings as those of the active window.
Cascade	Arranges the editing windows so that they overlap each other.
Tile	Arranges the editing windows so that they do not overlap each other.
Arrange Icons	When the editing windows are minimized, arranges their title bars.

View Menu The View menu contains commands that control the appearance of the ReMux application window. Table B-7 describes each of the View menu commands.

Table B-7: ReMux View menu commands

Command	Function
Toolbar	Toggles the display of the Toolbar on and off in the application window. A check mark precedes the command in the menu when the Toolbar is selected for display.
Status Bar	Toggles the display of the Status bar on and off in the application window. A check mark precedes the command in the menu when the Status bar is selected for display.

Help Menu The Help menu About ReMux command displays information including the ReMux software version number and copyright information.

ReMux Tutorials

This subsection describes the basics of operating the ReMux application.

Make S-TMCC TS Mode This mode allows you to create a transport stream of S-TMCC structure from a transport stream.

This subsection describes the procedure to create a transport stream of S-TMCC structure from a transport stream.

1. Select **File > New** or click the **New** button on the toolbar to open the **Select Remux Mode** dialog box shown in Figure B-2 on page B-5.
2. Select **Make S-TMCC TS** in the dialog box, and then click the **OK** button to open the editing window for the Make S-TMCC TS mode shown in Figure B-4.

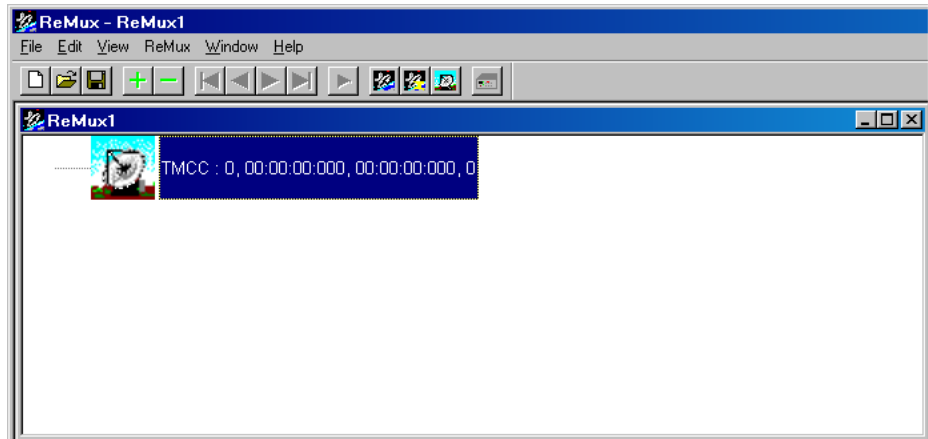
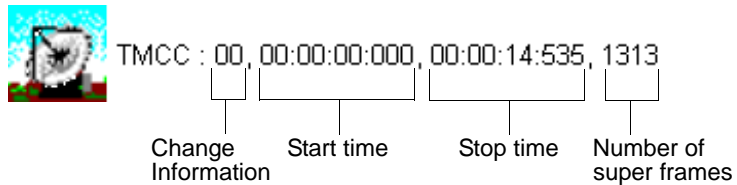

Figure B-4: Editing window for the Make S-TMCC TS mode

The information displayed to the right of the TMCC icon has the following meaning:



Selecting a Transport Stream File.

3. Select **Edit** > **Add** or click the + (Add) button on the toolbar to open the **Open** dialog box.
4. In the dialog box, select a transport stream file, and then click the **Open** button to open the **Edit TS Information** dialog box shown in Figure B-5.

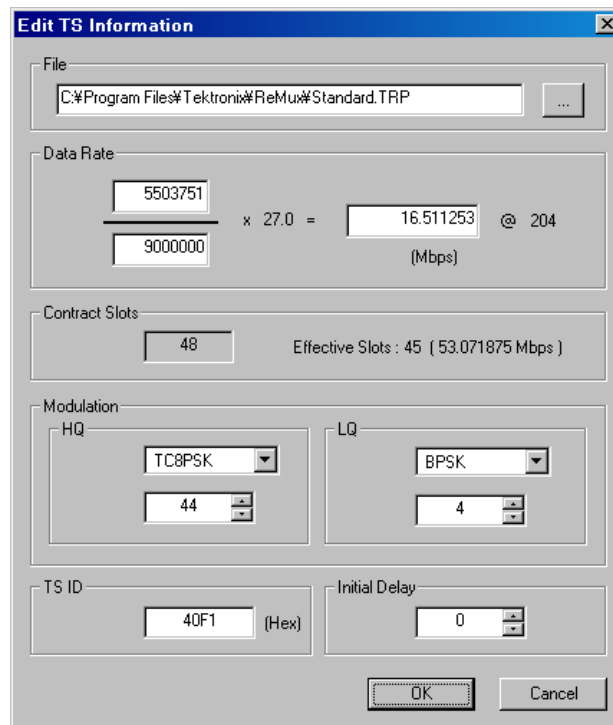

Figure B-5: Edit TS Information dialog box

In this dialog box, you can set the following parameters:

- **File:** Specifies the transport stream file to be converted to a transport stream file of S-TMCC structure.
- **Data Rate:** Specifies the data rate of the transport stream. You cannot set the value exceeding the data rate of the effective slots. If this value is less than the data rate of the effective slot, in addition, conversion of the data rate is done with the insertion of null packets.
- **Contract Slots:** Shows the number of contract slots. This value depends on the number of slots set in the Modulation item.
- **Modulation:** Specifies the modulation system and the number of slots to be assigned to HQ and LQ when performing hierarchical data transfer.
 - **HQ:** Specifies the modulation system and the number of slots to be assigned to HQ level.
 - **LQ:** Specifies the modulation system and the number of slots to be assigned to LQ level. This field is enabled only when the hierarchical control descriptor exists in PMT.

- **TS ID:** Specifies the transport stream ID. This value is used to change the ID value in TMCC, and the ID value in PAT is not changed.
 - **Initial Delay:** Specifies the number of delay packets (null packets) to be inserted at the start of re-multiplex. You can set the value in the range of 0 to 65535.
5. After you change the parameters, click the **OK** button to confirm the changes and close the dialog box.

This displays a transport stream icon under the TMCC icon (See Figure B-6).

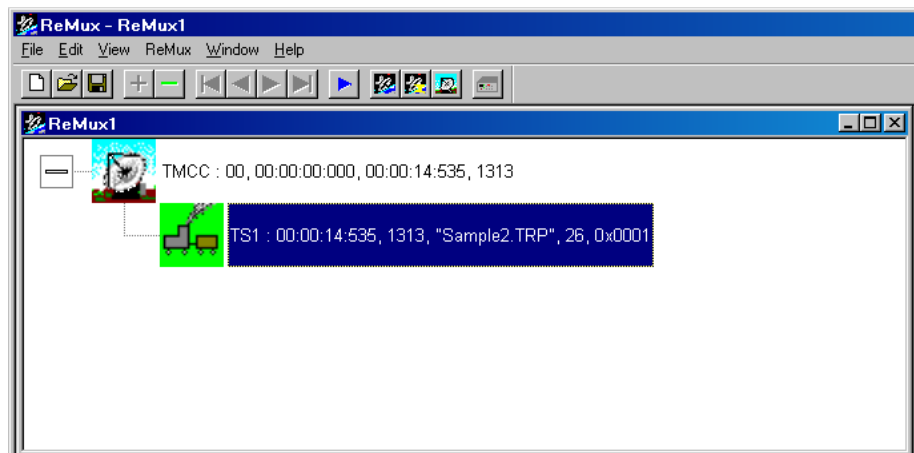
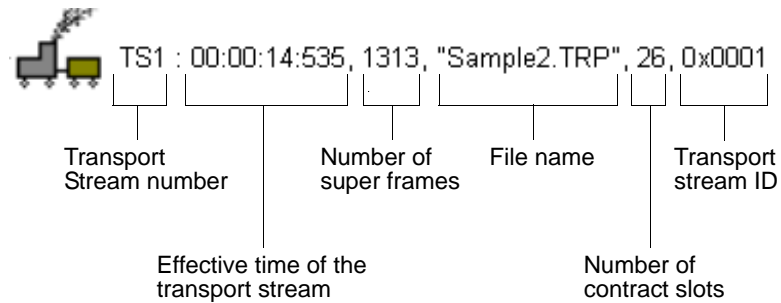

Figure B-6: Windows displaying a transport stream icon

The information displayed to the right of the transport stream icon has the following meaning:



Editing the TMCC Information for the Transport Stream.

6. Double-click the TMCC icon to open the Edit TMCC Information dialog box to edit the TMCC information for the transport stream (See Figure B-7).

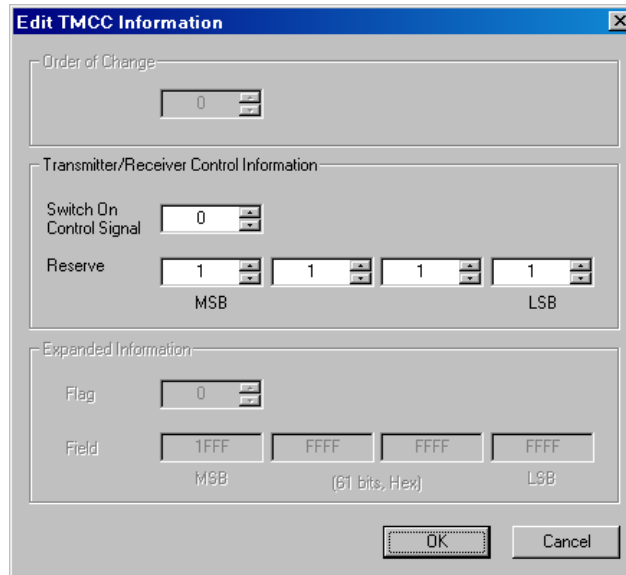

Figure B-7: Edit TMCC Information dialog box (S-TMCC)

In this dialog box, you can set the following parameters:

- **Transmitter/Receiver Control Information:** Sets the transmission/receiving control information.
 - **Switch On Control Signal:** Sets the start control signal to on (1) or off (0).
 - **Reserve:** Sets the reserve bit.
7. After you change the parameters, click the **OK** button to confirm the changes and close the dialog box.

Creating a Transport Stream of S-TMCC Structure.

8. Select **ReMux > Execute** or click the ► (Execute) button to open the **Save As** dialog box.
9. In the dialog box, specify a file name, and then click the **Save** button.

ReMux to M-TMCC TS from S-TMCC TS Mode

This mode allows you to create a transport stream of M-TMCC structure from a transport stream of S-TMCC structure.

This subsection describes the procedure to create a transport stream of M-TMCC structure from a transport stream of S-TMCC structure.

1. Select **File > New** or click the **New** button on the toolbar to open the **Select Remux Mode** dialog box shown in Figure B-2 on page B-5.
2. Select **ReMux to M-TMCC TS from S-TMCC TS** in the dialog box, and then click the **OK** button to open the editing window for the ReMux to M-TMCC TS from S-TMCC TS mode shown in Figure B-8.

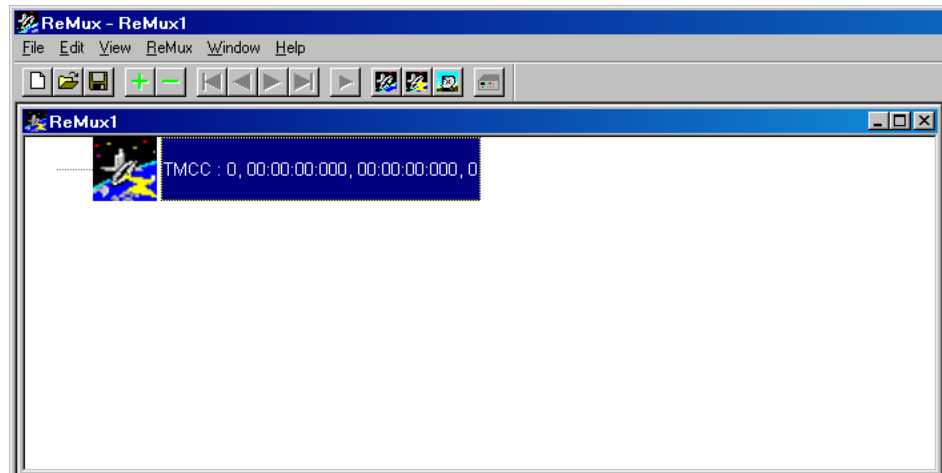

Figure B-8: Editing window for the ReMux to M-TMCC TS from S-TMCC TS mode

Selecting a Transport Stream File.

3. Select **Edit > Add** or click the + (Add) button on the toolbar to open the **Open** dialog box.
4. In the dialog box, select a transport stream file of S-TMCC structure, and then click the **Open** button to open the **Edit TS Information** dialog box shown in Figure B-5 on page B-10.

NOTE. If you select a transport stream file that does not have S-TMCC structure, an error message appears.

5. In the dialog box, set the parameters, and then click the **OK** button. This displays a transport stream icon in the window.

Multiplexing Transport Streams.

In the ReMux to M-TMCC TS from S-TMCC TS mode, you can multiplex transport streams of S-TMCC structure until the total number of slots reach 48.

6. Select **Edit > Add** or click the + (Add) button on the toolbar to open the **Open** dialog box.
7. In the dialog box, select a transport stream file of S-TMCC structure, and then click the **Open** button to open the **Edit TS Information** dialog box shown in Figure B-5 on page B-10.
8. In the dialog box, set the parameters, and then click the **OK** button.

This multiplexes the newly selected transport stream and the transport stream icon is added in the window (See Figure B-9).

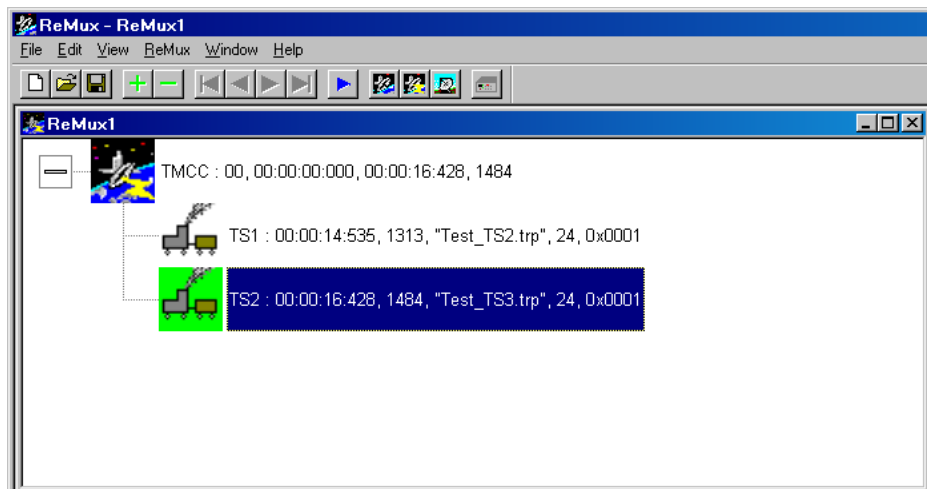

Figure B-9: Transport stream is multiplexed

9. If you want to multiplex more transport streams, repeat steps 6 through 8.

Editing the TMCC Information for the Transport Stream.

10. Double-click the TMCC icon to open the **Edit TMCC Information** dialog box for editing the TMCC information for the transport stream (See Figure B-10).

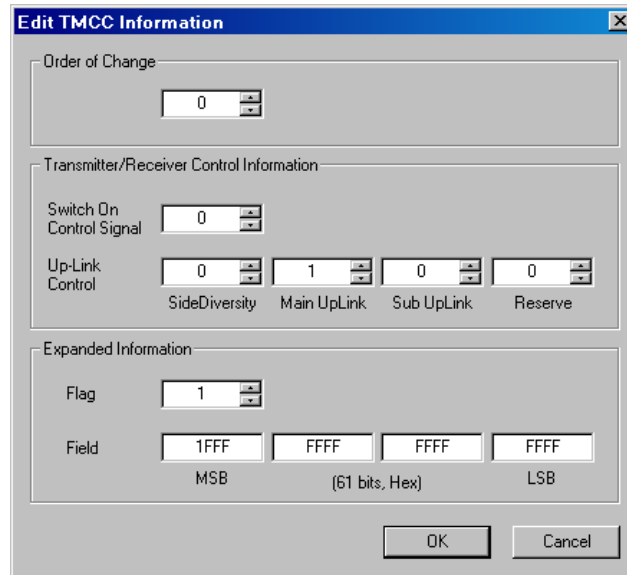

Figure B-10: Edit TMCC Information dialog box (M-TMCC)

In this dialog box, you can set the following parameters:

- **Order of Change:** Sets the TMCC change instruction. You can set the value in the range of 0 to 31.
 - **Transmitter/Receiver Control Information:** Sets the transmission/receiving control information.
 - **Switch On Control Signal:** Sets the control signal on (1) or off (0).
 - **Up-Link Control:** Controls the up-link switching.
 - **Extended Information:** Sets the extended information. When you set the Flag (extension flag) item to 1, the Field item becomes active.
11. After you change the parameters, click the **OK** button to confirm the changes and close the dialog box.

Creating a Transport Stream of M-TMCC Structure.

12. Select **ReMux > Execute** or click the ► (Execute) button to open the **Save As** dialog box.
13. In the dialog box, specify a file name, and then click the Save button.

If the number of slots of the transport stream of M-TMCC structure you are going to create is less than 48, a dummy transport stream(s) is(are) inserted so that the number of slots reach 48. The transport stream thus inserted has the ID value set in the OPTION dialog box (See Figure B-3 on page B-7) and TS8PSK is used as the modulation system.

Multiplexing Transport Streams of M-TMCC Structure with Different TMCC Information.

In the ReMux to M-TMCC TS from S-TMCC TS mode, you can multiplex a transport stream of M-TMCC structure with a transport stream of M-TMCC structure having different TMCC information.

14. Click the TMCC icon of the M-TMCC stream created in step 13.
15. Select **Edit > Add** or click the + (Add) button on the toolbar to open the **Add TMCC** dialog box as shown in Figure B-11.

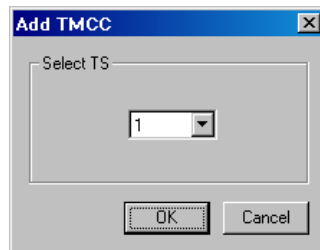
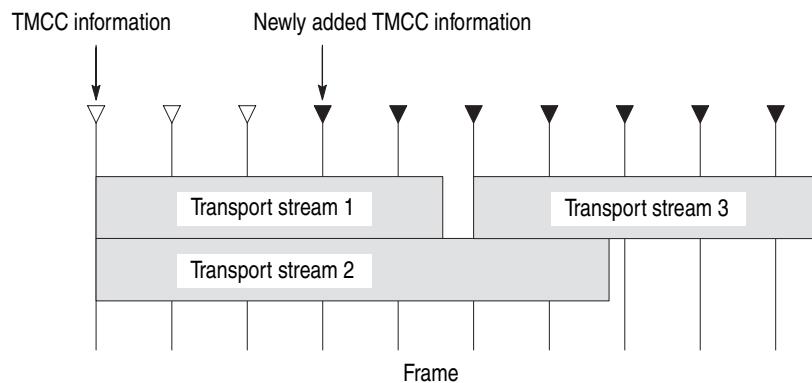

Figure B-11: Add TMCC dialog box

In this dialog box, you can specify the transport stream to which the new TMCC information is inserted if more than one transport stream is multiplexed.



This illustration shows the positional relationship when inserted TMCC information and the transport stream 3 after the transport stream 1 while two transport streams have been multiplexed. The new TMCC information is inserted two frames before the location in which the new transport stream is inserted.

16. In the Add TMCC dialog box, select a transport stream number, and then click the **OK** button to open the **Edit TMCC Information** dialog box for editing the TMCC information (See Figure B-10).
17. After you change the parameters, click the **OK** button to confirm the changes and close the dialog box.

This opens a new editing window with a TMCC icon displayed. In this case, note the increase of the value indicating change instruction at the right side of the TMCC icon. In addition, the **First** and **Previous** buttons on the toolbar change their color to green indicating that a TMCC exists before this TMCC.

18. Repeat steps 3 through 5 to select a transport stream file.
19. Repeat steps 6 through 8 to multiplex the transport stream file.
20. If you want to further multiplex a transport stream(s) of M-TMCC structure having different TMCC information, repeat steps 14 through 19.

Creating a Transport Stream of M-TMCC Structure.

21. Select **ReMux > Execute** or click the ► (Execute) button to open the **Save As** dialog box.
22. In the dialog box, specify a file name, and then click the **Save** button.

If the number of slots of the transport stream of M-TMCC structure you are going to create is less than 48, a dummy transport stream(s) is(are) inserted so that the number of slots reach 48. The transport stream thus inserted has the ID value set in the OPTION dialog box (See Figure B-3 on page B-7) and TS8PSK is used as the modulation system.

ReMux to M-TMCC TS Mode

This mode allows you to create a transport stream of M-TMCC structure from a transport stream. In this mode, two Remux functions are simultaneously executed: the Make S-TMCC TS and the ReMux to M-TMCC TS from S-TMCC TS mode.

This subsection describes the procedure to create a transport stream of M-TMCC structure from a transport stream.

1. Select **File > New** or click the **New** button on the toolbar to open the **Select Remux Mode** dialog box shown in Figure B-2 on page B-5.
2. Select **ReMux to M-TMCC** in the dialog box, and then click the **OK** button to open the edit window for the ReMux to M-TMCC TS mode shown in Figure B-12.

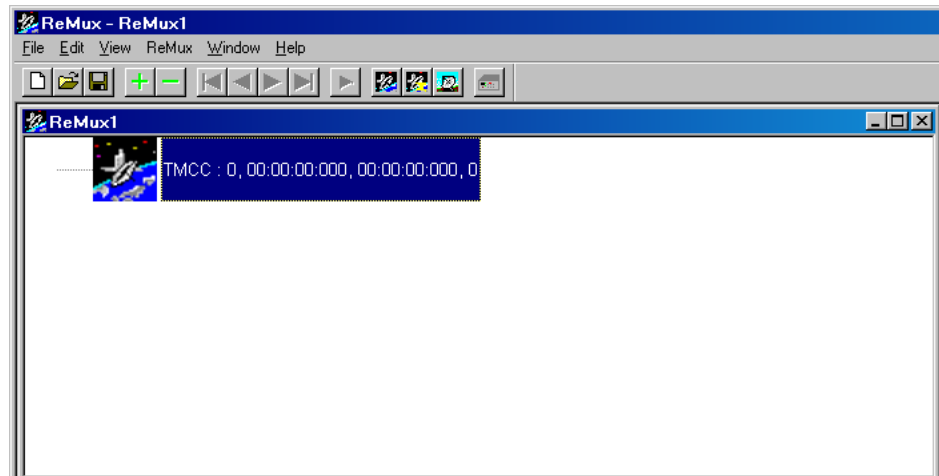

Figure B-12: Editing window for the ReMux to M-TMCC TS mode

Selecting a Transport Stream File.

3. Select **Edit > Add** or click the + (Add) button on the toolbar to open the **Open** dialog box.
4. In the dialog box, select a transport stream file, and then click the **Open** button to open the **Edit TS Information** dialog box shown in Figure B-5 on page B-10.

5. In the dialog box, set the parameters, and then click the **OK** button. This will display a transport stream icon in the window.

Multiplexing Transport Streams.

6. Perform steps 6 through 9 on page B-14 to multiplex the transport streams.

Editing the TMCC Information for M-TMCC. 7.

7. Perform step 10 on page B-15 to edit the TMCC information for M-TMCC.

Multiplexing Transport Streams of M-TMCC Structure with Different TMCC Information.

8. Perform steps 14 through 20 on pages B-16 and B-17 to multiplex the transport stream of M-TMCC structure having different TMCC information.

Creating a Transport Stream of M-TMCC Structure.

9. Perform steps 21 and 22 on page B-17 to create a transport stream of M-TMCC structure.

DeMux M-TMCC TS Mode

This mode allows you to de-multiplex (separate) the original transport stream from a transport stream of M-TMCC structure. The resulting de-multiplexed transport stream is bit-rate converted to a packet form of 204 bytes.

This subsection describes the procedure to de-multiplex the original transport stream from a transport stream of M-TMCC structure.

1. Select **ReMux > DeMux** or click the **DeMux M-TMCC TS** button on the toolbar to open the Open dialog box.

2. In the dialog box, select a transport stream file of M-TMCC structure, and then click the **Open** button to open the editing window for the DeMux M-TMCC TS mode shown in Figure B-13.

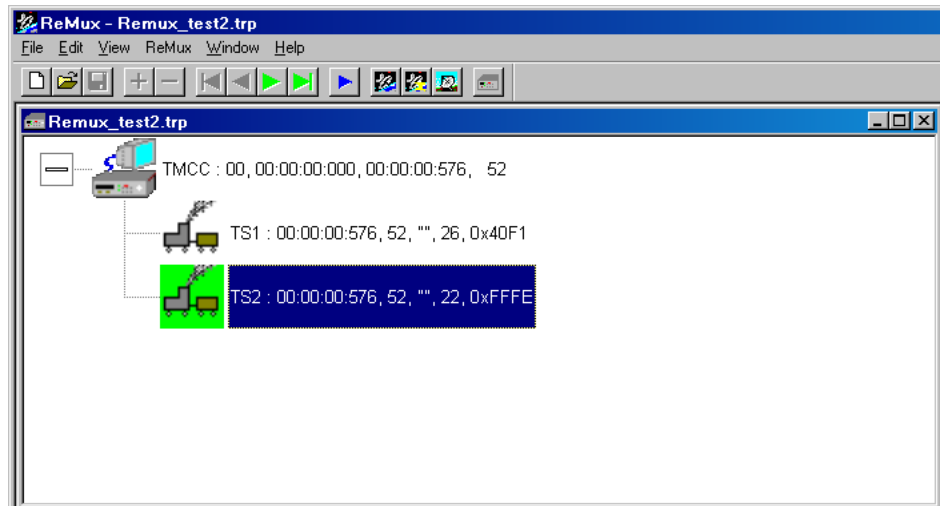

Figure B-13: Editing window for the DeMux M-TMCC TS mode

NOTE. *If you select a transport stream file that does not have M-TMCC structure, an error message appears.*

3. Select **ReMux > Execute** or click the ► (Execute) button to open the **DEMUX** dialog box shown in Figure B-14.

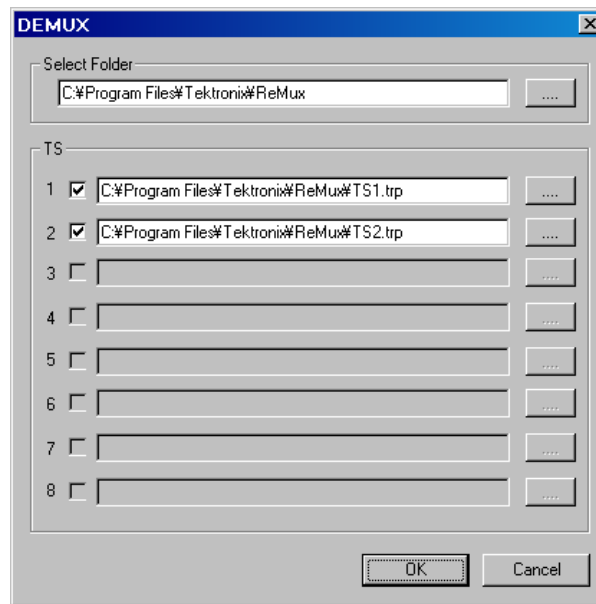

Figure B-14: DEMUX dialog box

In this dialog box, you can set the following parameters:

- **Save to:** Specifies the directory to which the de-multiplexed transport stream is to be saved.
 - **TS:** Selects the transport stream(s) to be de-multiplexed. Click the check box at the front of the file name to select the file to be de-multiplexed. When you click the ... button to the right of the file name, the Save As dialog box appears, and you can specify a file name and save the file.
4. After you select the directory and transport stream(s), click the **OK** button. The transport stream(s) is (are) de-multiplexed and saved to the directory.

Appendix C: Using the Scheduler Application (Option SC Only)

Scheduler is a software application that provides scheduling capability for the MTX100A. The application enables you to create a schedule list of streams for subsequent play or record.

This appendix describes the functions of the Scheduler application and how to create a schedule list, and play and record streams within the list.

Scheduler can be installed on a PC using the product CD-ROM. When installing the application on a remote, networked PC, you can create a schedule list on the remote PC and play or record streams. Refer to *Installing Scheduler on a PC* on page C-23 for the installation procedure.

Starting and Exiting Scheduler

To start the Scheduler application on the MTX100A, select **File > Scheduler** in the Play or Record screen.

- **In the Play screen:** Starts Scheduler in the schedule play mode. This mode allows you to create a schedule list and play streams.
- **In the Record screen:** Starts Scheduler in the schedule record mode. This mode allows you to create a schedule list and record streams.

NOTE. *The Scheduler menu command appears only when the software protection key is installed on the Printer port of the MTX100A.*

To exit (quit) the Scheduler application, select **File > Exit** or click the **Close** button in the upper-right corner of the application window.

Elements of the Scheduler Application Window

Figure C-1 shows the Scheduler application window. The window contains a title bar, a menu bar, a toolbar, a status/control panel, a schedule list, and a status bar.

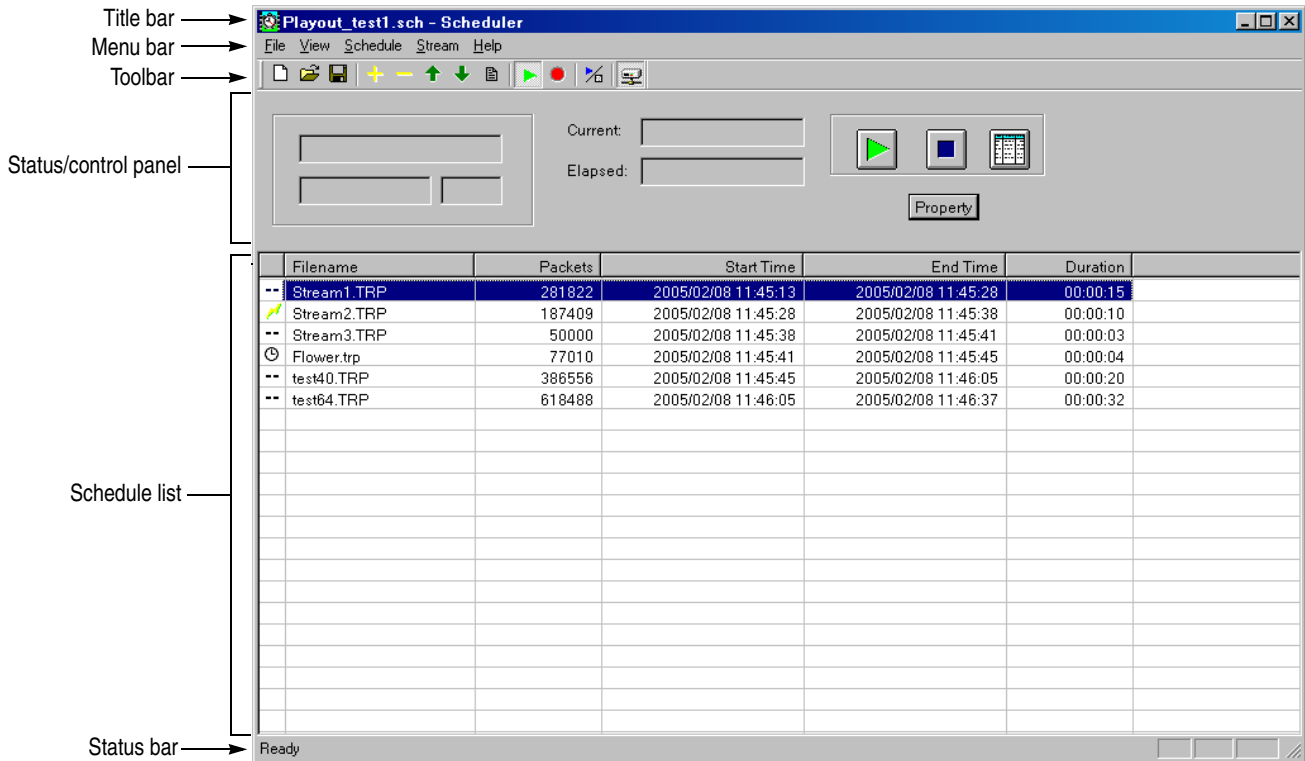













Figure C-1: Scheduler application window (schedule play mode)

Title Bar The title bar displays the file name of the currently selected schedule list and the name of the application. It also contains the standard window-sizing boxes for Windows.

Menu Bar The menu bar displays the names of the pull-down menus. Refer to *Using the Scheduler Menus* on page C-5 for detailed information about the functions available in the menus.

Toolbar The Toolbar provides shortcut buttons for many of the most often used menu commands. Click a toolbar button to select the corresponding command. You can toggle the toolbar display on and off using the Toolbar commands in the View pull-down menu. Table C-1 describes the function of each toolbar button.

Table C-1: Toolbar button descriptions

Icon	Name	Function
	New	Equivalent to the New command in the File menu.
	Open	Equivalent to the Open command in the File menu.
	Save	Equivalent to the Save command in the File menu.
	Add	Equivalent to the Add command in the Stream menu.
	Delete	Equivalent to the Delete command in the Stream menu.
	Move up	Equivalent to the Move Up command in the Stream menu.
	Move down	Equivalent to the Move Down command in the Stream menu.
	Properties	Equivalent to the Properties command in the Stream menu.
	Play	Equivalent to the Play command in the Schedule menu.
	Record	Equivalent to the Record command in the Schedule menu.
	Execute	Equivalent to the Execute command in the Schedule menu.
	Connect	Equivalent to the Connect command in the Schedule menu.

Status/Control Panel The status/control panel appears when you select the Execute command from the Schedule menu or click the Execute button on the toolbar. This panel allows you to set properties for the whole schedule list, and start/stop stream playout or record. Refer to *Status/Control Panel* on page C-15 for detailed information.

Schedule List Lists the streams currently included in the schedule. The schedule list is composed of the following items:

■ **Schedule icon:** The following icons are displayed in front of the file name:



This icon shows that no start time or triggered start has been specified for the stream.



This icon shows that the start time has been specified for the stream.



This icon shows that a triggered start has been specified for the stream.

These icons change depending on the Start Time option setting in the Play Properties or Record Properties dialog box. Refer to *Play Properties Dialog Box* on page C-10 and *Record Properties Dialog Box* on page C-14.

■ **Filename:** Shows the file name of the stream.

■ **Packets:** Shows the number of packets contained in the stream (For a Non TS stream, it shows the number of bytes). This item does not appear in the schedule record mode.

■ **Start time:** Shows the start date/time for the stream.

■ **End time:** Shows the end date/time for the stream.

■ **Duration:** Shows the duration time of the stream.

Streams can be selected by clicking the stream name. Only one stream can be selected at a time.

When you start playing or recording streams, the background of the schedule list changes to gray, and the stream currently being played or recorded is highlighted.

Status Bar The status bar displays a short explanation of the currently selected command and information related to the operation. You can toggle the status bar display on and off using the Status Bar command in the View pull-down menu.

Using the Scheduler Menus

The Menu bar displays the names of the five pull-down menus. This section describes the function of each selection in these menus.

File Menu The File menu contains commands for managing file operations and for exiting the Scheduler application. Table C-2 describes each of the File menu commands.

Table C-2: File menu commands

Command	Function
New	Opens a new (blank) schedule.
Open	Opens the Open dialog box where you can select a schedule list file (*.sch).
Save	Saves the currently selected schedule list.
Save As	Opens the Save As dialog box where you can save the currently selected schedule list.
1 xxx.sch ... 4 xxx.sch	Lists up to four of the most recently opened schedule list files. When you select a filename, the schedule opens.
Exit	Exits the application.

View Menu The View menu contains commands that control the appearance of the application window. Table C-3 describes each of the View menu commands.

Table C-3: View menu commands

Command	Function
Show message	Opens the Show error message dialog box that lists all errors that have occurred in the MTX100A.
Toolbar	Toggles the display of the Toolbar on and off in the application window. A check mark precedes the command in the menu when the toolbar is selected for display.
Status Bar	Toggles the display of the Status bar on and off in the application window. A check mark precedes the command in the menu when the status bar is selected for display.

Schedule Menu The Schedule menu contains commands that control the remote connection to the MTX100A and changes between the play mode and record mode. Table C-4 describes each of the Schedule menu commands.

Table C-4: Schedule menu commands

Command	Function
Connect	Opens the MTX/RTX Host Name dialog box. Refer to <i>MTX/RTX Host Name Dialog Box</i> below for detailed information about the dialog box.
Disconnect	Closes the connection to the MTX100A.
Play	Sets the schedule play mode.
Record	Sets the schedule record mode.
Settings	Opens the Scheduler Settings dialog box. Refer to <i>Scheduler Settings Dialog Box</i> on page C-7 for detailed information about the dialog box.
Execute	Displays the status/control panel in the application window. Refer to <i>Status/Control Panel</i> on page C-15 for detailed information.

MTX/RTX Host Name Dialog Box. When you select the Connect command from the Schedule menu, the MTX/RTX Host Name dialog box appears as shown in Figure C-2.

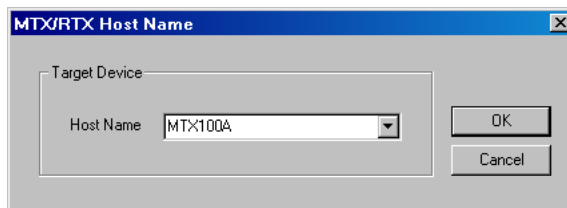

Figure C-2: MTX/RTX Host Name dialog box

- **Host Name:** Selects the host name of the MTX100A to which Scheduler is connected.

Scheduler Settings Dialog Box. When you select the Settings command from the Schedule menu, the Scheduler Settings dialog box appears as shown in Figure C-3.

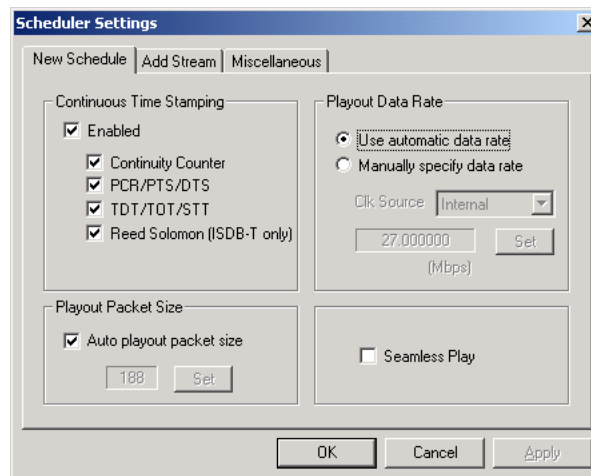

Figure C-3: Scheduler Settings dialog box

There are three tabs in the Schedule Settings dialog box: New Schedule, Add Stream, and Miscellaneous.

New Schedule tab

- **Continuous Time Stamping:** Specifies which parameters in the transport stream should be modified when looping a transport stream to simulate continuous playout. After selecting the Enabled check box, select the appropriate parameter(s) you intend to modify. The parameters are updated by the system hardware (27 MHz clock).
- **Playout Packet Size:** When you select the Auto playout packet size check box, the default packet size displayed is derived from the first stream added to the schedule list. However, if the first stream in the schedule list is a Non TS stream, the packet size of subsequent streams is set to 188 bytes.

If you clear the **Auto playout packet size** check box, the **Set** button becomes available. When you click the **Set** button, the Set Custom Clock dialog box appears. In this dialog box, you can set the appropriate packet size.

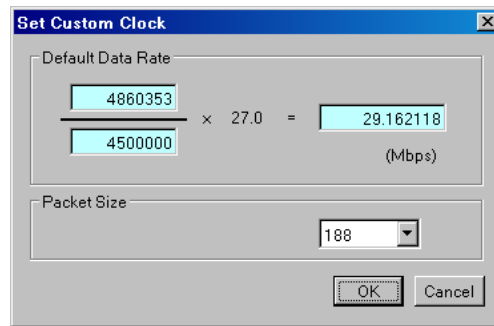

- **Default Data Rate:** Sets the default bit rate.
- **Packet Size:** Sets the default packet size. You can select 188, 204, and 208.
- **Playout Data Rate:** Sets the playout bit rate for the overall schedule.
 - **Use automatic playout data rate:** Uses the bit rate derived from the first stream in the schedule list.
 - **Manually specify a playout data rate:** Uses a clock source and bit rate that you specify. When you select this option, the Clk Source list box and the Set button become available. Use the Calk Source list box to select a clock source for the stream playout. You can select Internal, ExtRef 10M, ExtRef 27 M, ExtRef IFFT, Ext P Clk, or Ext S Clk. Refer to *Clock Dialog Box* on page 3-7 for detailed information about each clock source. When you click the Set button, the Set Custom Clock dialog box appears. In this dialog box, you can set the appropriate bit rate.
- **Seamless Play:** Sets whether or not the streams in the schedule list are continuously played with no discontinuities. Normally, stream output stops at every file, changing points if each stream has different bit rate. When it is checked, all the streams are played using the same bit rate set by the Playout Bitrate options.

NOTE. You cannot play a Non TS or M-TMCC stream(s) using the Seamless Play mode.

If you play streams that have different packet sizes using the Seamless Play mode, click the Enabled check box in the Continuous Time Stamping field to deselect the check box.

If you play streams that have different bit rates using the Seamless Play mode, the Fixed ES Rate setting in the MTX100A does not work properly.

Add Stream tab

- **Playout Properties:** Sets the default playout properties (bit rate and packet size) to be used when a stream is added to a schedule list.
 - **from Schedule:** Uses the settings in the dialog box.
 - **from Source:** Uses the default bit rate and packet size derived from the original stream.
 - **Custom:** Uses the custom bit rate and packet size set in the tab. When you select this option, the Set Custom Clock dialog box appears.

Miscellaneous tab

- **Loop Mode:** Sets whether the schedule is run in loop mode. When it is checked, the current schedule is restarted when it reaches the end of the last stream.

NOTE. You cannot use the loop mode if there is a stream having a time or triggered start specified in a schedule list.

- **Local lock out:** Sets whether the front-panel lockout function is enabled or not. When it is checked, all front-panel buttons are disabled.
- **Port:** Sets the port number of the MTX100A to which Scheduler is connected. The default value is 49152.

Stream Menu

The Stream menu contains commands to add, delete, and move a stream in the schedule list. It also contains the command to view and set the stream properties of the currently selected stream. Table C-5 describes each of the Stream menu commands.

Table C-5: Stream menu commands

Command	Function
Move up	Moves the currently selected stream one position up in the schedule list. If the stream is currently at the top of the list, this command has no effect.
Move down	Moves the currently selected stream one position down in the schedule list. If the stream is currently at the bottom of the list, this command has no effect.
Add	<ul style="list-style-type: none"> ■ For the schedule play mode: Opens the Open dialog box where you can select a stream to be added to the schedule list. ■ For the schedule record mode: Opens the Save as dialog box where you can specify a path and file name for the stream file to be recorded. Refer to <i>Save as Dialog Box</i> on page C-13.

Table C-5: Stream menu commands (cont.)

Command	Function
Delete	Deletes the currently selected stream from the schedule list.
Properties	<ul style="list-style-type: none"> ■ For the schedule play mode: Opens the Play Properties dialog box for the selected stream. Refer to <i>Play Properties Dialog Box</i> on page C-10. ■ For the schedule record mode: Opens the Record Properties dialog box for the selected stream. Refer to <i>Record Properties Dialog Box</i> on page C-14.

Play Properties Dialog Box. If Scheduler is set to the schedule play mode, when you select the Properties command from the Stream menu, the Play Properties dialog box appears as shown in Figure C-4. This dialog box allows you to display the properties for the selected stream, and set the start/stop position and the start time of the stream. This dialog box can be displayed by selecting Properties from the right-click menu or by double-clicking the stream name.

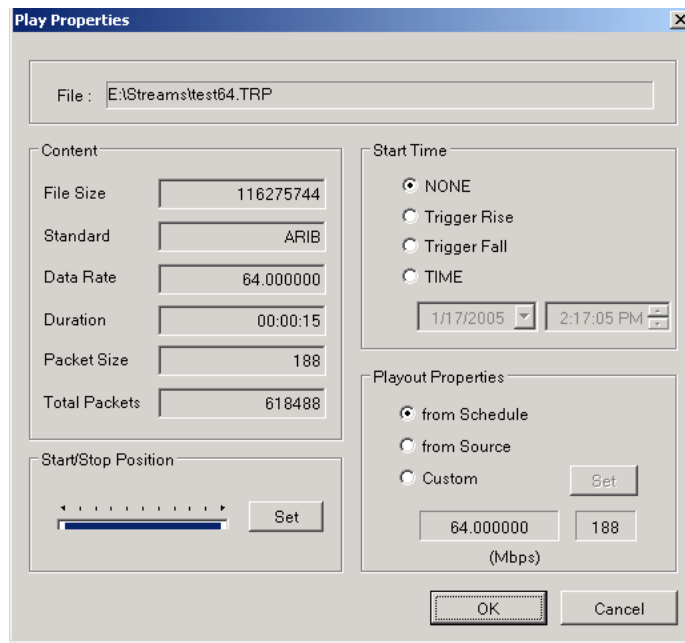
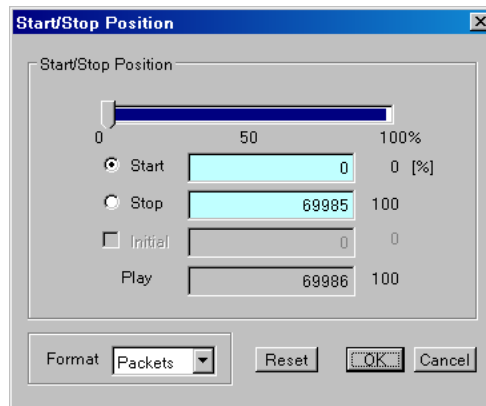

Figure C-4: Play Properties dialog box

- **File:** Show the name and location of the stream.
- **Content:** Shows the content of the stream.
 - **File Size:** Shows the file size of the stream in bytes.

- **Standard:** Shows the standard of the stream (MPEG2, ARIB, DVB, ATSC, S-TMCC, M-TMCC, ISDB-T, or NON TS).
- **Data Rate:** Shows the bit rate derived from the PCRs in the stream.
- **Duration:** Shows the duration of the stream.
- **Packet Size:** Shows the packet size of the stream. For a Non TS file, a dash is displayed.
- **Total Packets:** Shows the total number of the packets in the stream. For a Non TS file, a dash is displayed.
- **Start/Stop Position:** Sets the start and stop positions of the stream. When you click the Set button, the Start/Stop Position dialog box allows you to set the start/stop position.



- **Start:** Sets the start position of the stream by the number of packets (the number of super frames for a M-TMCC file, or the number of bytes for a Non TS file).
- **Stop:** Sets the stop position of the stream by the number of packets (the number of super frames for a M-TMCC file, or the number of bytes for a Non TS file).
- **Play:** Shows the actual number of packets (the number of super frames for a M-TMCC file, or the number of bytes for a Non TS file) that is calculated by the values of the Start and Stop text boxes.
- **Format:** Shows the setting unit of the start and stop positions of the stream. It shows Packets for a transport stream file, SF (super frame) for a M-TMCC file, and Bytes for a Non TS file.

For an ISDB-T file, the start packet is defined as the first-appearing packet including an OFDM frame start flag after the specified start position. The stop packet is defined as the packet at the front of the last-appearing packet including an OFDM frame start flag before the specified stop position. At this time, if the number of OFDM frames between the start packet and stop packet is not an even number, the packet in the last OFDM frame becomes the stop packet.

First, specify the format for the setting in the Format list box at the bottom of the dialog box. Next, click the Start or Stop option button, and then set the number of packets or time using the slider. You can directly enter the desired values in the text boxes.

- **Start Time:** Specifies the time at which the stream will start to play within a schedule. If the Seamless Play option is selected in the Schedule Settings dialog box, this field is disabled.

NONE: The stream is integrated into the schedule and obeys the overall timing of the schedule. It will follow on from the previous stream without a break in the playout bit stream.

Trigger Rise: The stream playout starts on the rising edge (low to high transition) of the trigger signal applied to the TRIG IN connector. When you select this option, spin boxes to set date and time become available.

Trigger Fall: The stream playout starts on the falling edge (high to low transition) of the trigger signal applied to the TRIG IN connector. When you select this option, spin boxes to set date and time become available.

NOTE. *If the trigger does not occur within a specified time, the subsequent stream will be played out.*

TIME: The stream playout starts at an absolute time. When you select this option, spin boxes to set date and time become available.

- **Playout Properties:** Sets the playout bit rate and packet size of the stream. If the Seamless Play option is selected in the Schedule Settings dialog box, this field is disabled.

from Schedule: Uses the values from the Schedule Settings dialog box (see Figure C-3).

from Source: Uses the original bit rate and packet size of the stream.

Custom: Uses the bit rate and packet size specified in the Play Properties dialog box. When you select this option, the Set button becomes available. Click the Set button, and then set the appropriate bit rate and packet size in the resulting Set Custom Clock dialog box.

Save as Dialog Box. If Scheduler is set to the schedule record mode, when you select the Add command from the Stream menu, the Save as dialog box appears as shown in Figure C-5.

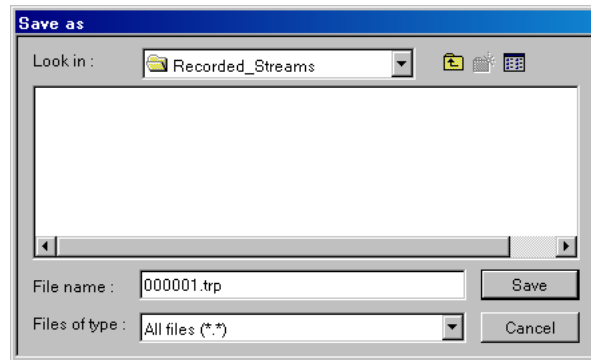

Figure C-5: Save as dialog box

Use this dialog box to do the following:

1. Select the appropriate drive and directory for the stream file you are going to record.
2. Specify a file name for the stream. You can use the default file name that is automatically displayed in the File name text box. The following characters must not be used in a file name: \ / : , ; * ? " < > |
3. Click the **Save** button to add the stream file to a schedule list.

When you click the Save button, the Record Properties dialog box appears. Refer to *Record Properties Dialog Box* on page C-14 for more information.

Record Properties Dialog Box. If Scheduler is set to the schedule record mode, when you select the Add command from the Stream menu and click the Save button on the Save as dialog box, the Record Properties dialog box appears as shown in Figure C-6. This dialog box allows you to set the start time, recording time, and stop time for the stream to be recorded. This dialog box can be displayed by selecting Properties from either the right-click menu or Stream menu or by double-clicking the stream name.

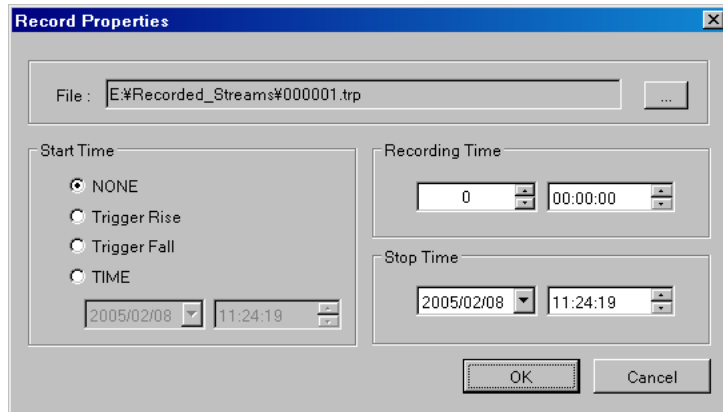

Figure C-6: Record Properties dialog box

- **File:** Shows the directory path and file name for the stream to be recorded.
- **Start Time:** Specifies the time at which a stream will start to record. The choices are:
 - **NONE:** The stream is integrated into the schedule and obeys the overall timing of the schedule. It will follow on from the previous stream without a break.
 - **Trigger Rise:** The stream record starts on the rising edge (low to high transition) of the trigger signal applied to the TRIG IN connector. When you select this option, spin boxes to set date and time become available.
 - **Trigger Fall:** The stream record starts on the falling edge (high to low transition) of the trigger signal applied to the TRIG IN connector. When you select this option, spin boxes to set date and time become available.

NOTE. *If the trigger does not occur within a specified time, the subsequent stream will be recorded.*

- **TIME:** The stream record starts at an absolute time. When you select this option, spin boxes to set date and time become available.

- **Recording Time:** Specifies the recording time for the stream.
- **Stop Time:** Specifies the time at which a stream will stop recording. When you click the down arrow (▼) at the right side of the date spin box, a calendar allows you to set a date.

Help Menu The Help menu About Scheduler command displays information including the Scheduler software version number and copyright information.

Status/Control Panel

The status/control panel (see Figure C-7) appears when you select the Execute command from the Schedule menu or click the Execute button on the toolbar. This panel allows you to set properties for the whole schedule list, and start and stop the stream playing and recording.

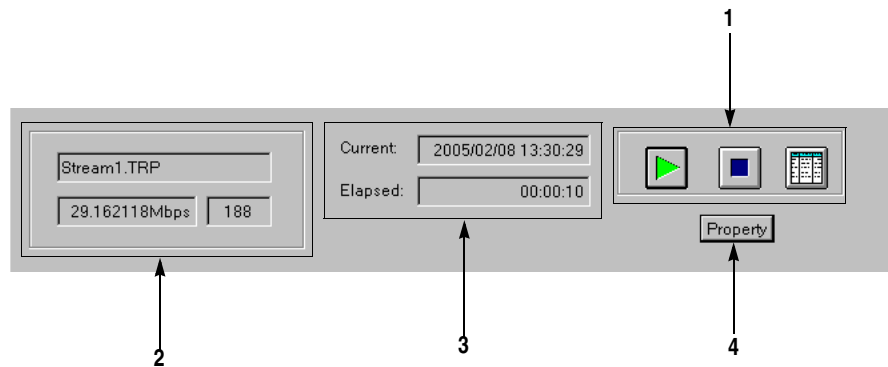

Figure C-7: Status/control panel (schedule play mode)

1. **Control buttons.** Controls the schedule playing and recording, and the application window display.



Play button: Starts the schedule playing. This button is displayed in the schedule play mode.



Record button: Starts the schedule recording. This button is displayed in the schedule record mode.



Stop button: Stops the schedule playing or recording.



Schedule list button: Closes the status/control panel.

2. **Stream information.** Shows the file name, bit rate, and packet size of the stream currently being played or recorded.
3. **Payout or record status.** Shows the following time information:
 - Current:** Shows the current date and time.
 - Elapsed:** Shows the elapsed time from the start of the stream currently being played or recorded.
4. **Property button.** Displays the Schedule Property dialog box shown in Figure C-8.

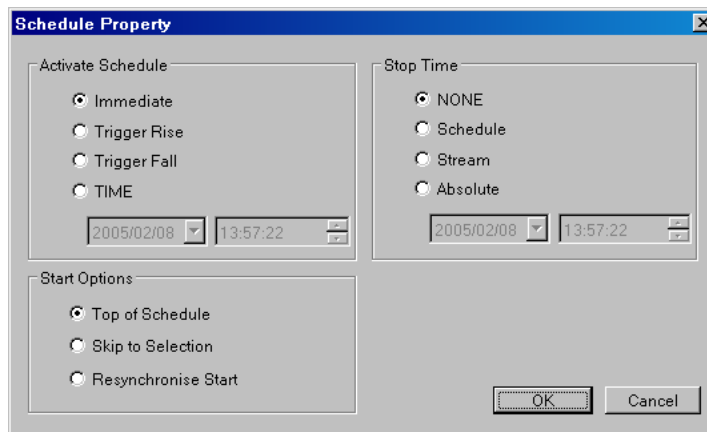

Figure C-8: Schedule Property dialog box

- **Activate Schedule:** Sets the way in which the schedule activates. The setting in this field affects the Start Time setting of a stream at the top of the schedule list.
 - **Immediate:** In the schedule play mode, the schedule playing starts as soon as you click the Play button on the status/control panel. In the schedule record mode, the schedule recording starts as soon as you click the Record button on the status/control panel.
 - **Trigger Rise:** The schedule playing or recording starts on the rising edge (low to high transition) of the trigger signal applied to the TRIG IN connector. When you select this option, spin boxes to set date and time become available.
 - **Trigger Fall:** The schedule playing or recording starts on the falling edge (high to low transition) of the trigger signal applied to the TRIG IN connector. When you select this option, spin boxes to set date and time become available.

NOTE. *If the trigger does not occur within a specified time, the subsequent stream will be played out or recorded.*

- **TIME:** The schedule playing or recording starts by an absolute starting time. When you select this option, spin boxes to set date and time become available.
- **Start Options:** Sets the actual time when the schedule starts.
 - **Top of Schedule:** The schedule playing or recording starts with the first stream in the schedule list.
 - **Skip to Selection:** The schedule playing or recording starts at the currently highlighted stream. If no stream is highlighted, the schedule will start at the top of the schedule list. This option is only available when you select Immediate in the Active Schedule field.
 - **Resynchronize Start:** The start time of the first stream is adjusted to equal to the current time (the first stream must have an absolute Start Time specified). This option is only available when you select Immediate in the Active Schedule field.
- **Stop Time:** Sets the way in which the schedule stops playing or recording.
 - **NONE:** The schedule plays or records through according to the start and stop times of the individual streams.
 - **Schedule:** The schedule playing or recording stops at the specified date and time but not until the current (schedule) pass is completed. When you select this option, spin boxes to set date and time become available.
 - **Stream:** The schedule playing or recording stops at the specified date and time but not until the current stream is completed. When you select this option, spin boxes to set date and time become available.
 - **Absolute:** The schedule playing or recording stops immediately at the specified date and time. When you select this option, spin boxes to set date and time become available.

Scheduler Tutorials

This section describes the basics of operating the Scheduler application. The application has the following two operating modes:

- Schedule play mode
- Schedule record mode

Schedule Play Mode

The schedule play mode allows you to create a schedule list defined playout properties of streams and playout up to 256 streams continuously. You can set the start and stop positions, absolute start time, bit rate, and packet size as playout properties for each stream.

In the schedule play mode, you can play five kinds of stream files:

- Transport stream (188/204/208) file
- S-TMCC file
- M-TMCC file
- ISDB-T file
- Non TS file

Perform the following procedure to create a schedule list and play streams:

Creating a Schedule List

1. Select **Schedule > Play** or click the **Play** button on the toolbar to set Scheduler to the schedule play mode.
2. Select **Schedule > Settings** to open the **Scheduler Settings** dialog box (see Figure C-3 on page C-7).
3. In the **New Schedule** tab, set parameters to be updated, playout packet size, and playout bit rate. You can also set whether or not the streams in the schedule list are continuously played with no discontinuities.
4. Click the **Add Stream** tab.
5. In the **Add Stream** tab, set playout properties used when a stream is added to the schedule.
6. Click the **Miscellaneous** tab.
7. In the **Miscellaneous** tab, set the loop mode, the local lock out status, and the port number. The port number needs to be the same port number as the MTX100A.

8. Click the **OK** button to confirm the changes and close the dialog box.
9. Select **Stream > Add** or click the **Add** button on the toolbar to open the **Open** dialog box.
10. In the **Open** dialog box, select a file to be added to the schedule list and click the **Open** button.
11. Repeat steps 9 and 10 until all the stream files you want to play are added to the schedule list. You can add up to 256 files in a single schedule.
12. Select **Schedule > Execute** or click the **Execute** button on the toolbar to open the status/control panel.
13. Click the **Property** button on the panel to open the **Schedule Property** dialog box (see Figure C-8 on page C-16).
14. In the **Schedule Property** dialog box, set conditions to activate, start, and stop the schedule.
15. If you want to set properties for an individual stream, use the following methods to open the **Play Properties** dialog box (see Figure C-4 on page C-10):
 - Highlight the stream name you want to set (by clicking on the name on the schedule list), and then select Properties from the Stream menu.
 - Double-click the stream name you want to set.
 - Right-click the stream name you want to set, and select Properties from the pop-up menu.
16. In the **Play Properties** dialog box, set the start/stop positions, start time, and playout properties for the stream.

Schedule Playout Timing

Schedule playout timing is determined by the Active Schedule setting in the Schedule Property dialog box and the Start Time setting in the Play Properties dialog box.

- When you add a stream to a new schedule list with no Active Schedule date/time set, the Start Time is set to the current date/time. The start times of streams subsequently added to the schedule list are cumulative.

Filename	Packets	Start Time	End Time	Duration
-- Stream1.TRP	281822	2005/02/09 9:23:48	2005/02/09 9:24:03	00:00:15
-- Stream2.TRP	187409	2005/02/09 9:24:03	2005/02/09 9:24:13	00:00:10
-- Stream3.TRP	50000	2005/02/09 9:24:13	2005/02/09 9:24:16	00:00:03
-- test40.TRP	386556	2005/02/09 9:24:16	2005/02/09 9:24:36	00:00:20
-- test64.TRP	618488	2005/02/09 9:24:36	2005/02/09 9:25:08	00:00:32

- If you set an Active Schedule date/time (for example, 2005/2/12 12:00:00) in the Schedule Property dialog box, this is applied to all streams.

Filename	Packets	Start Time	End Time	Duration
-- Stream1.TRP	281822	2005/02/12 12:00:00	2005/02/12 12:00:15	00:00:15
-- Stream2.TRP	187409	2005/02/12 12:00:15	2005/02/12 12:00:25	00:00:10
-- Stream3.TRP	50000	2005/02/12 12:00:25	2005/02/12 12:00:28	00:00:03
-- test40.TRP	386556	2005/02/12 12:00:28	2005/02/12 12:00:48	00:00:20
-- test64.TRP	618488	2005/02/12 12:00:48	2005/02/12 12:01:20	00:00:32

- If you set a Start Time (for example, 2005/2/10 15:00:00) in the Play Properties dialog box for an individual stream, the start date/time of all subsequent streams are changed. This does not affect the preceding streams.

Filename	Packets	Start Time	End Time	Duration
-- Stream1.TRP	281822	2005/02/09 9:34:38	2005/02/09 9:34:53	00:00:15
-- Stream2.TRP	187409	2005/02/09 9:34:53	2005/02/09 9:35:03	00:00:10
⌚ Stream3.TRP	50000	2005/02/10 15:00:00	2005/02/10 15:00:03	00:00:03
-- test40.TRP	386556	2005/02/10 15:00:03	2005/02/10 15:00:23	00:00:20
-- test64.TRP	618488	2005/02/10 15:00:23	2005/02/10 15:00:55	00:00:32

NOTE. If there is an inconsistent time setting between the Schedule Property and Play Properties dialog boxes or between two streams, an error message appears.

Saving a Schedule List

17. Perform one of the two following methods to save the schedule list:

- Select **Save** from the **File** menu to either save a new schedule list or resave an existing schedule list.
- Select **Save As** from the **File** menu to save a schedule list under a different name.

Playing Streams

18. Click the **Play** button (▶) on the status/control panel to start the schedule.

Schedule Record Mode

The schedule record mode allows you to create a schedule list for stream files to be recorded and record an input stream continuously on the hard disk drive of the MTX100A. You can set record properties for each stream, and record up to 256 stream files.

Perform the following procedure to create a schedule list and record streams.

Creating a Schedule List

1. Select **Schedule > Record** or click the **Record** button on the toolbar to set the schedule record mode.
2. Select **Stream > Add** or click the **Add** button on the toolbar to open the **Save as** dialog box (see Figure C-5 on page C-13).
3. In the **Save as** dialog box, specify the appropriate drive, directory, and file name for the stream file to be recorded. You can use the default file name that is automatically displayed in the file name text box.
4. Click the **Save** button to open the **Record Properties** dialog box (see Figure C-6 on page C-14).
5. In the **Record Properties** dialog box, set the start time and stop time (or recording time) for the stream.
6. Repeat steps 2 through 5 for all the files that you want to record.
7. Select **Schedule > Execute** or click the **Execute** button on the toolbar to open the status/control panel.
8. Click the **Property** button on the panel to open the **Schedule Property** dialog box (see Figure C-8 on page C-16).
9. In the **Schedule Property** dialog box, set conditions to activate, start, and stop the schedule.

Schedule Record Timing

Schedule record timing is determined by the Active Schedule setting in the Schedule Property dialog box and the Start Time setting in the Record Properties dialog box. The timing is set using the same method as described in Schedule Payout Timing. Refer to *Schedule Payout Timing* on page C-19.

Recording Streams

10. Click the **Record** button (●) on the status/control panel to start the schedule.

NOTE. *You cannot change a property in the schedule while a schedule is running.*

If you try to run a schedule with past time assigned, an error message appears. If this happens, change the Start Time setting of the corresponding stream(s).

If you output streams having different bit rates continuously, to output each stream in a specific bit rate, the instrument requires the times to accumulate a certain amount of data in FIFO and output the last data from FIFO. Therefore, the actual start and end times of streams are slightly different from the displayed Start and End times in a schedule list.

Any discontinuity may be caused by streams that have different payout properties.

If you output streams from the SMPTE 310 interface (Option 06), set the bit rate to 19.392658 Mbps and set the packet size to 188 bytes.

In the schedule record mode, the Without Limit feature of the MTX100A is automatically set to on.

Installing Scheduler on a PC

This section describes how to install the Scheduler application on your PC. The application is included in the *MTX100A & RTX100A Application Software Recovery* CD-ROM (Tektronix part number: 063-3866-XX).

PC System Requirement Before installing the Scheduler application, check that your PC meets the following minimum requirements:

- Windows 2000/XP operating system
- CD-ROM drive (for software installation)

Installation Instructions The following instructions install the Scheduler application on your PC and create a desktop shortcut icon on the PC to run Scheduler.

Perform the following procedure to install Scheduler:

1. Log on to Windows (2000 or XP) as Administrator.
2. Insert the **MTX100A & RTX100A Application Software Recovery** CD into a CD-ROM drive on your PC.
3. Double-click the **My Computer** icon.
4. Double-click the **CD-ROM drive** icon.
5. Double-click the **PC_Scheduler** folder.



CAUTION. *To prevent data loss, it is strongly recommended that you exit any open applications on your PC before you run the Scheduler setup.exe file.*

6. Double-click the **setup.exe** icon in the list. The Scheduler installation program displays a series of setup windows as listed in the following sub-steps. Click the **Next>** button to accept the default parameters, or change the parameters in the setup windows to suit your needs. Click the **Back** button in a setup window to return to the previous setup window.
 - a. Welcome window. Read the displayed information, and then click the **Next** button to proceed with the installation.
 - b. Choose Destination Location window. The default directory location for the application is displayed. If you want to install Scheduler in a custom location, click the **Browse...** button, and then select or create a custom directory location.

- c. Select Program Folder window. The default name for the program folder is displayed. If you want to change the name, type in a new name, or select a name from the Existing Folders list. Click the **Next>** button to proceed.
 - d. Start Copying Files window. Review the displayed information, and then click the **Next>** button to start the installation.
 - e. Setup Complete window. If the installation is successful, you will see a message that setup has finished installing the Scheduler application onto your PC. If you want to run Scheduler immediately, select **Yes, Launch the program file**, and then click the **Finish** button. To exit the installation program without running Scheduler, click the **Finish** button.
7. Remove the **MTX100A & RTX100A Application Software Recovery** CD from your PC and then store the CD in a safe location.

Creating a Desktop Shortcut Icon. Perform the following procedure to create an icon on your PC desktop that you can use to run the Scheduler application.

1. On your PC display, move the mouse cursor to any unoccupied desktop area, and then click the right mouse button to open the desktop menu.
2. From the desktop menu, select **New**, and then select **Shortcut** to open the Create Shortcut dialog box.
3. Click the **Browse...** button in the Create Shortcut dialog box.
4. Use the Browse dialog box to locate the Scheduler directory.
 - a. If you installed the Scheduler application using the default directory location and the default folder name in the installation procedure, select the following directory folders in order: **Program Files**, **Tektronix**, and **Scheduler**.
 - b. If you installed the Scheduler application to a custom location or gave the application folder a custom name, you will need to select your custom directory path.
 - c. You should now be at a location in the PC directory structure where the browse list box shows the **Scheduler.exe** file.
5. Select the **Scheduler.exe** file (Scheduler.exe will be displayed in the file name box), and then click the **Open** button. The directory path to the Scheduler.exe file will now be displayed in the Command Line box of the Create Shortcut dialog box.
6. Click the **Next>** button in the Create Shortcut dialog box. The default name of the shortcut icon is now displayed in the dialog box. You can edit the icon name to suit your needs or accept the default name.

7. Click the **Finish** button to finish creating the desktop shortcut icon. The scheduler.exe shortcut icon will now appear on the PC desktop. You can start the Scheduler application by double-clicking the **Scheduler.exe** (or your custom name) shortcut icon.

Starting and Exiting Scheduler on Your PC

When you complete the installation procedure, you can use any of the following methods to start the Scheduler application:

- Double-click the Scheduler.exe shortcut icon on the PC desktop that you created during the installation procedure.
- Select Scheduler from the **Start - Programs** menu.

When starting Scheduler, the MTX/RTX Host Name dialog box appears as shown below. In this dialog box, you can select an MTX100A to be controlled by Scheduler. After you select the MTX100A, click the **OK** button.

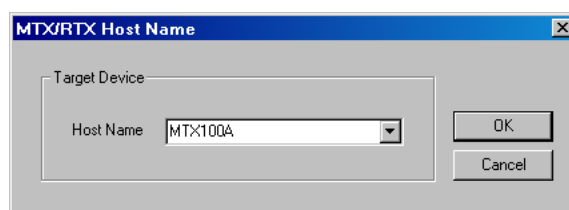

NOTE. Do not play or record streams for about one minute after you power on the MTX100A.

To exit (quit) the Scheduler application, select **Exit** from **File** menu command list or click the close box on the title bar.

Appendix D: Control Signal for Option 02

For the MTX100A Option 02, the control signals for the hierarchical multiplexing parameters are output from the Universal In/Out connector when outputting an ISDB-T transport stream.

This appendix describes the pin assignments of the Universal In/Out connector when the control signals are output and shows the timing relationship of these signals.

Table D-1 lists the pin assignment of the Universal In/Out connector.

Table D-1: Pin assignment of the Universal In/Out connector

Characteristics	Description			
Universal In/Out connector	D-sub, 25 pin			
Connect type	D-sub, 25 pin			
Pin assignment	1	Clock ¹	14	$\overline{\text{Clock}}$
	2	GND	15	$\overline{\text{GND}}$
	3	CD3	16	$\overline{\text{CD3}}$
	4	CD2	17	$\overline{\text{CD2}}$
	5	CD1	18	$\overline{\text{CD1}}$
	6	CD0	19	$\overline{\text{CD0}}$
	7	HFLAG3	20	$\overline{\text{HFLAG3}}$
	8	HFLAG2	21	$\overline{\text{HFLAG2}}$
	9	HFLAG1	22	$\overline{\text{HFLAG1}}$
	10	HFLAG0	23	$\overline{\text{HFLAG0}}$
	11	NC	24	$\overline{\text{NC}}$
	12	Frame	25	$\overline{\text{Frame}}$
	13	GND		

- 1 The clock frequency can be selected from 4 MHz, 8 MHz, 16 MHz, or 32 MHz using the PI Clock command in the Univ I/F menu.

Figure D-1 shows the timing relationship of the signals on the Universal In/Out connector.

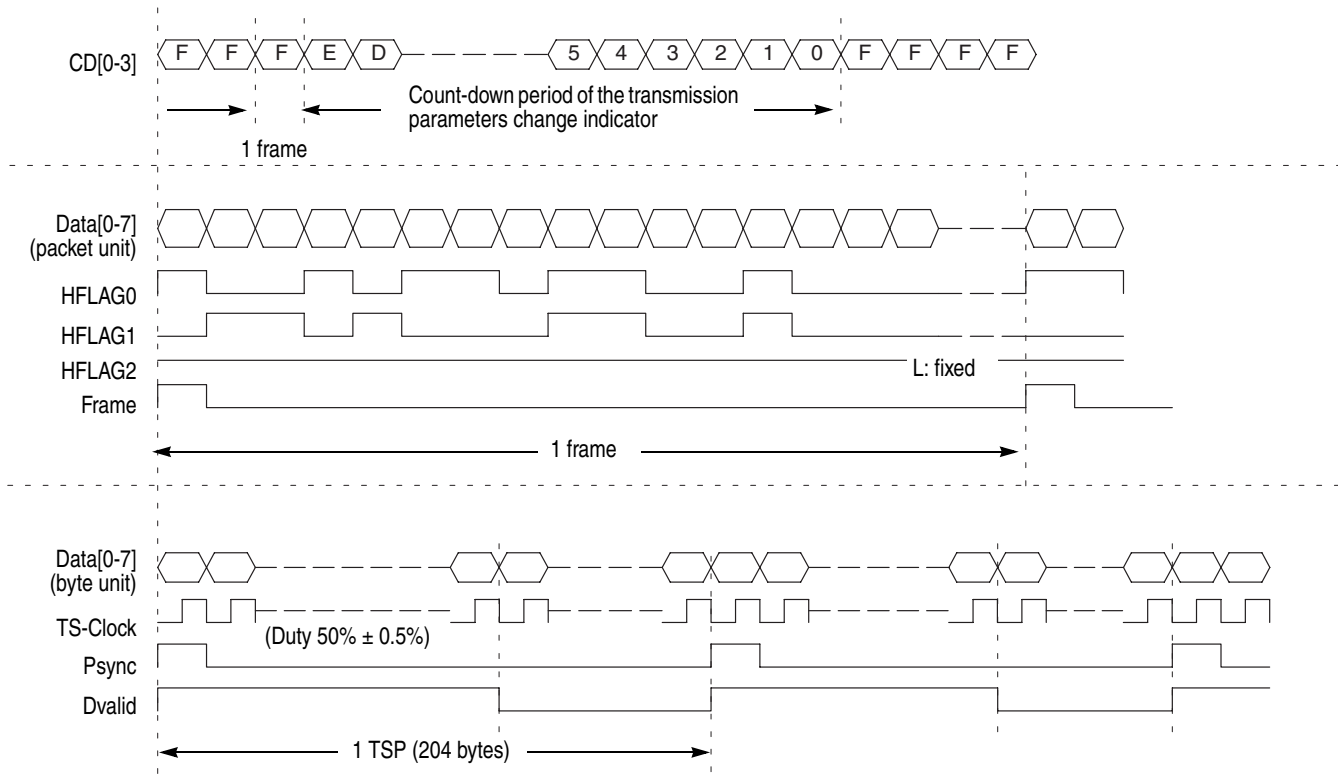

Figure D-1: Timing relationship of the signals on the Universal In/Out connector

Appendix E: Defragment the Hard Disk Drive

The MTX100A displays the following messages when fragmentation occurs and data output or data record rate is slower than the specified characteristics.

- *FIFO is underflow* (when data is being output)
- *FIFO is overflow* (when data is being acquired)

If this condition happens, you need to optimize the hard disk drive by performing the Disk Defragmenter of Windows XP. This appendix provides instructions on how to defragment the hard disk drive.

Procedure Perform the following procedure to defragment the hard disk drive:

1. Connect the keyboard and mouse provided with the instrument to the USB port on the front panel.
2. Select **File > Exit** in the Play or Record screen to exit the MTX100A application. This appears on the Windows XP desktop.
3. Select **Programs > Accessories > System Tools > Disk Defragmenter** from the Start menu. The **Disk Defragmenter** window appears as shown in Figure E-1.

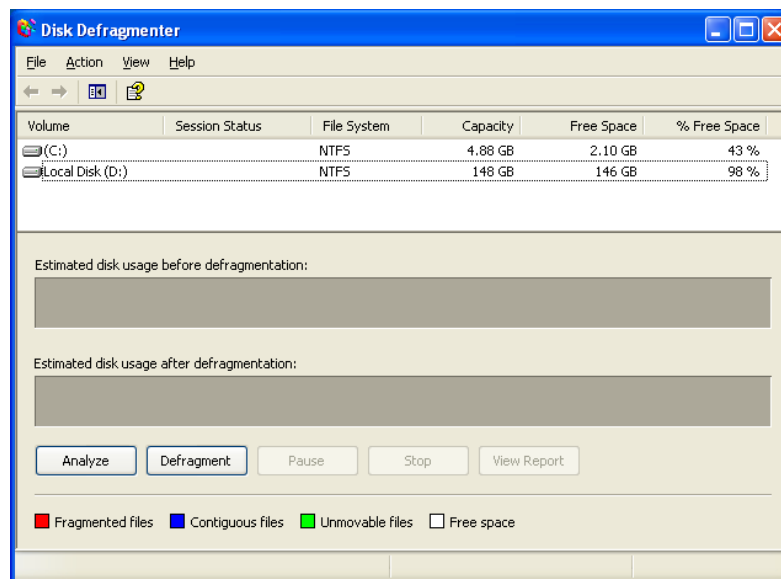

Figure E-1: Disk Defragmenter window

4. Click **Local Disk (D:)**.
5. Click the **Defragment** button to start the defragmentation. When the defragmentation is completed, the **Defragmentation Complete** dialog box appears as shown in Figure E-2.

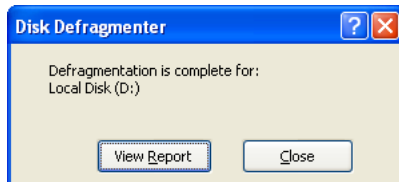

Figure E-2: Defragmentation Complete dialog box

6. Click the **Close** button.
7. Click the **Close** button at the upper right of the screen to close the Disk Defragmenter window.

Appendix F: Using the Recovery Discs

In the event the MTX100A does not boot, you can reboot the MTX100A by using the recovery discs provided with the instrument. Use the procedures in this appendix to reinstall the Windows XP operating system and the MTX100A application software.

Reinstalling Windows XP

Perform the following procedure to reinstall the Windows XP operating system:

1. Insert the **Windows XP Professional Operating System Recovery Disc** into the DVD drive.
2. Turn off, then turn on the instrument. The MTX100A runs from the disc.
3. Follow the installing instructions on the screen.
4. When the **Easy Restore** window appears, click **Continue** to start the recovery process.
5. Click **Yes** in the **Warning** dialog box to continue the process. The process takes about 10 minutes.
6. When the **Message** dialog box appears, press the eject button of the DVD drive, and then press any key to reboot the instrument.
7. When the **Windows XP Professional Setup** dialog box appears, follow the installing instructions on the screen.

When all settings for Windows XP are completed, the Windows desktop appears.

Reinstalling the MTX100A Application

Perform the following procedure to reinstall the MTX100A application software:

1. Insert the **MTX100 & RTX100A Application Software Recovery Disc** into the DVD drive.
2. Double-click the **E: drive** icon (substitute your DVD drive letter if it is different than E).
3. Double-click the **Application_Software** folder.
4. Double-click the **setup.exe** icon. This installs the MTX100A application software.

Installing the Parallel Driver (Option SC Only)

Perform the following procedure to reinstall the parallel driver:

1. Double-click the **Driver** folder in the **MTX100A & RTX100A Application Software Recovery Disc**.
2. Double-click the **SSD5411-32bit.exe** icon.
3. Click **Next** in the resulting window. The **License Agreement** window appears.
4. Select **I accept the terms in the license agreement**, and then click **Next**. The **Destination Folder** window appears.
5. Click **Next**. The **Setup Type** window appears.
6. Select **Complete** and click **Next**. The **Ready to Install Program** window appears.
7. Click **Install** to proceed with installation.
8. When the **InstallShield Wizard Completed** window appears, click **Finish** to complete the installation.

Restoring the IEEE1394b Port Speed Setting

The IEEE1394 port speed of the MTX100A is set to S400/S800 at the factory. However, when you reinstall the Windows XP operating system, this setting returns to the default value (S400). After you reinstall the operating system, perform the following procedure to restore the IEEE1394b port speed setting:

1. Select **Start > Run** to open the Run dialog box.
2. Enter **regedit** in the Run dialog box, and then click **OK**. This opens Registry Editor window.
3. In the Registry Editor window, select the following directory path:

```
HKEY_LOCAL_MACHINE\SYSTEM\CurrentControlSet\Enum\
PCI\VEN_104C&DEV_8025&SUBSYS_80251268&REV\
5&23d05aab&0&3068F0\Device Parameters
```
4. In the file list on the right side of the window, double-click the **SidSpeed** icon. This opens the Edit DWORD Value dialog box.
5. In the Edit DWORD Value dialog box, enter **3** in the **Value data** text box.
6. Click **OK** to close the Edit DWORD Value dialog box and apply the setting change.
7. Click the close button (X) on the title bar to close the Registry Editor window.

Appendix G: Inspection and Cleaning

Inspect and clean the instrument as often as your operating conditions require. The collection of dirt can cause instrument overheating and operational failure. Dirt acts as an insulating blanket, preventing efficient heat dissipation. Dirt also provides an electrical conduction path that can cause an instrument failure, especially under high-humidity conditions.



CAUTION. *Avoid the use of chemical cleaning agents that might damage the plastics used in this instrument. Use only deionized water when cleaning the front-panel controls. Use a 75% ethyl alcohol solution as a cleaner and rinse with deionized water.*

Avoid the use of high-pressure compressed air when cleaning dust from the interior of this instrument. High-pressure air can cause Electro Static Discharge (ESD). Instead, use low-pressure compressed air (about 9 psi).

Exterior Inspection

Inspect the outside of the instrument for damage, wear, and missing parts. You should thoroughly check instruments that appear to have been dropped or otherwise abused to verify correct operation and performance. Have a qualified service technician immediately repair defects that could cause personal injury or lead to further damage to the instrument.

Exterior Cleaning

Perform the following steps when you clean the exterior of the instrument:



WARNING. *To avoid injury or death, unplug the power cord from the line voltage before cleaning the instrument. Avoid getting moisture inside the instrument during external cleaning. Use only enough liquid to dampen the cleaning cloth.*

1. Remove loose dust on the outside of the instrument with a lint-free cloth.
2. Remove remaining dirt with a lint-free cloth dampened with a general purpose detergent-and-water solution. Do not use abrasive cleaners.
3. Clean the monitor screen with a lint-free cloth dampened with a gentle, general purpose detergent-and-water solution.



Glossary

Glossary

ACTS (Advanced Communications Technologies and Services)

A set of telecommunication research projects financed by the European Union.

ARIB

Association of Radio Industries and Businesses.

ATSC

Advanced Television Systems Committee.

BAT (Bouquet Association Table)

One of the tables defined by DVB-SI. The BAT provides information regarding bouquets (collections of services marketed as a single entity). DVB only.

CAT (Conditional Access Table)

One of the PSI tables described by the MPEG-2 standard. The CAT provides the association between one or more CA systems, their EMM (Entitlement Management Message) streams, and any special parameters associated with them.

CRC (Cyclic Redundancy Check)

One of the fields described in the MPEG-2 standard. CRC is used to verify the correctness of data in PSI and SI tables.

Defragmentation

The process of rewriting parts of a file to contiguous sectors on a hard disk to increase the speed of access and retrieval. When files are updated, the computer tends to save these updates on the largest continuous space on the hard disk, which is often on a different sector than the other parts of the file. When files are thus "fragmented," the computer must search the hard disk each time the file is accessed to find all of the file's parts, which slows down response time.

DVB (Digital Video Broadcast)

A project group of the European Broadcasting Union (EBU).

DVB-MG

Digital Video Broadcasting - Measurement Guidelines.

DVB-SI (Digital Video Broadcast Service Information)

The DVB-SI adds the information that enables DVB IRDs to automatically tune to particular services and allows services to be grouped into categories with relevant schedule information. It has several tables, including: NIT, SDT, BAT, and EIT. (NIT is also required for MPEG-2.)

DTS (Decoding Time-Stamp)

One of the fields described in the MPEG-2 standard. The DTS may be present in a PES packet header that indicates the time that an access unit is decoded in the T-STD.

ECM (Entitlement Control Message)

Private conditional access information that specifies control words and possibly other, typically stream-specific, scrambling and/or control parameters.

EISA (Extended Industry Standard Architecture)

The PC bus used to communicate with the CARB and PIA boards.

EIT (Event Information Table)

One of the tables defined by DVB-SI. The EIT contains data concerning events (a grouping of elementary broadcast data streams with a defined start and end time belonging to a common service) and programs (a concatenation of one or more events under the control of a broadcaster, such as event name, start time, and duration).

EMM (Entitlement Management Message)

Private conditional access information that identifies the authorization levels or the services of specific decoders.

ETS (European Telecommunication Standard)

One of the types of documents released by ETSI.

ETSI

European Telecommunications Standards Institute.

ETR (ETSI Technical Report)

One of the types of documents released by ETSI.

IRD (Integrated Receiver / Decoder)

A receiving decoder that can automatically configure itself using the MPEG-2 Program Specific Information (PSI).

ISDB-T (Integrated Services Digital Broadcasting-Terrestrial)

The Japanese broadcasting standard developed by ARIB. In ISDB-T, the television, radio, and data services are covered by one standard.

ISO (International Standard Organization)

Organization responsible for establishing standards at the world-wide level.

MPEG-2

A standard developed by MPEG (Moving Picture Experts Group) for the compression of digital video.

NIT (Network Information Table)

One of the PSI tables described by the MPEG-2 standard and also one of the tables defined by DVB-SI. The NIT conveys information relating to the physical organization of the multiplex; that is, transport streams carried via a given network and the characteristics of the network itself. Transport streams are identified by the combination of an original network ID and a transport stream ID in the NIT.

PAT (Program Association Table)

One of the PSI tables described in the MPEG-2 standard. The PAT provides information about the structure of a transport stream.

PCR (Program Clock Reference)

One of the fields defined in the MPEG-2 standard. A time stamp in the transport stream from which decoder timing is derived.

PES (Packetized Elementary Stream)

A structure defined in the MPEG-2 standard used to carry elementary stream data.

PID (Packet Identifier)

One of the fields described in the MPEG-2 standard. A unique integer value used to identify elementary streams of a program in a single or multiprogram TS.

PMT (Program Map Table)

One of the PSI tables described by the MPEG-2 standard. The PMT identifies and indicates the locations of the streams that make up each service and the location of the Program Clock Reference (PCR) fields for a service. This table is transmitted in sections.

PSI (Program Specific Information)

A set of tables described by the MPEG-2 standard. The PSI contains all of the tables that define the MPEG-2 transport stream. It consists of the PAT, PMT, CAT, and NIT tables. (NIT is also used for DVB-SI.)

PSIP

Program and System Information Protocol.

PTS (Presentation Time Stamp)

One of the fields described in the MPEG-2 standard. The PTS may be present in a PES packet header that indicates the time that a presentation unit is presented in the T-STD.

RST (Running Status Table)

One of the tables defined by DVB-SI. The RST gives a quick updating mechanism for the status information carried in the EIT.

SDT (Service Description Table)

One of the tables defined by DVB-SI. The SDT contains data describing the services in the system. Examples include: names of services and the service provider.

SI (Service Information)

Set of tables defined by DVB-SI. The SI provides information on services and events carried by different Multiplexes, and even other networks. SI is structured as six tables (PAT, NIT, CAT, SDT, EIT, and BAT). The applications are only concerned with NIT, BAT, SDT, and EIT.

ST (Stuffing Table)

One of the tables defined by DVB-SI. The ST provides stuffing sections.

TDT (Time & Date Table)

One of the tables defined by DVB-SI. The TDT carries the current time and date information.

TOT (Time Offset Table)

One of the tables defined by DVB-SI. The TOT gives information about a local time offset in a given area.

TS (Transport Stream)

A bit stream that contains 0 or more elementary streams combined in a manner that conforms to the MPEG-2 standard.

T-STD (Transport Stream System Target Decoder)

Described by the MPEG-2 standard, the T-STD is a hypothetical reference model of a decoding process used to define the semantics of a TS.



Index

Index

Numerics

10 key pad, 2-15
310M/ASI/SPI menu (Option 07 only), 3-22, 3-33

A

AC line voltage requirement, 1-6
ADFERR icon, 3-49
Arguments
 parameters, 3-78
Arrow buttons, 2-3
ASI I/F menu (Option 01 only), 3-19, 3-30
ASI interface (Option 01), 2-11
ASI/1394 menu (Option 05 only), 3-20, 3-31
ASI/IEEE1394 conversion, 3-129
AUDIO icon, 3-48
AUDIO_AAC icon, 3-48
AUDIO_AC3 icon, 3-48

B

Backus-Naur Form, 3-81
Basic menu operation, 2-14
BAT icon, 3-50
BIT icon, 3-50
BNF (Backus-Naur form), 3-81

C

CAT icon, 3-46
Certifications and Compliances, A-12
CETT icon, 3-50
Clock dialog box, 3-7
Clock/Ref In connector, 2-4
Com connector, 2-5
Commands
 chaining, 3-79
 rules for forming, 3-77
 structure of IEEE 488.2 commands, 3-81
 syntsx, 3-77
Common commands, 3-84
Communication dialog box, 3-23
Connecting to a Network, 3-67
Continuous recording, 3-57
Creating commands, 3-77
Crossover Ethernet cable, 3-67
CVCT icon, 3-50

D

DATA icon, 3-48
Data output source
 Hard disk, 2-17
 RAM, 2-17
Data probing, 3-128
DATA_SECT icon, 3-49
DCT icon, 3-50
Default settings, 3-115
DISPLAY commands, 3-86
Display elements, 2-5
Displaying the Windows screen, 1-12
DIT icon, 3-50
DLT icon, 3-50
DSM_CC icon, 3-49
DVD+/-RW drive, 2-1

E

ECM icon, 3-49
EETT icon, 3-50
EIT icon, 3-50
Electrical specifications, A-2
EMM icon, 3-49
ENTER button, 2-3
Environment operating requirements, 1-5
Environmental characteristics, A-11
Error codes, 3-119
 command, 3-119
 device specific, 3-122
 execution, 3-120
 query, 3-122
ERT icon, 3-50
ESC button, 2-3
Exiting the ReMux application, B-1
Exiting the Scheduler application, C-1
Expansion card slot, 2-4

F

File counter, 3-60
File menu (Play screen), 3-3
File menu (Record screen), 3-26
Front-panel controls, 2-1
Functional check procedure, 1-10
Functional specifications, A-1

G

GARBAGE icon, 3-50
GHOST icon, 3-49

Glossary, Glossary-1

H

HDD access indicator, 2-3
Hierarchy display, 2-7, 3-37
Hierarchy display icons, 3-38

I

Icon cursor, 2-7
IEEE 488.2 common commands, 3-81
IEEE1394 dialog box, 3-21
IEEE1394 dialog box (Record screen), 3-32
IEEE1394 interface
 ASI/IEEE1394 conversion, 3-129
 data probing, 3-128
 point-to-point connection, 3-126
IEEE1394/ASI interface (Option 05), 2-12
IEEE1394b connector, 2-5
Initial product inspection, 1-5
Installation, 1-5
ISDB-T icon, 3-45
ITT icon, 3-50

L

LAN connector, 2-5
LCD display, 2-1
LDT icon, 3-50
LIT icon, 3-50
Loading a preset file, 3-64

M

MASS MEMORY commands, 3-86
Mechanical characteristics, A-11
Menu bar, 2-7
MENU button, 2-2
MGT icon, 3-50
M-TMCC, xiii
M-TMCC icon, 3-45

N

NBIT icon, 3-50
NIT icon, 3-46
Non TS icon, 3-45
NULL icon, 3-49
Numeric input, 2-15

O

ON/STBY power switch, 2-1
Optional Accessories, 1-4
Optional commands, 3-107
Optional interface cards, 2-11
Options, 1-4
Others dialog box, 3-14, 3-29
Outputting an ISDB-T transport stream, 3-73

P

Partial transport stream, 3-131
PAT icon, 3-46
PCAT icon, 3-50
PCR icon, 3-47
PCR Inaccuracy dialog box, 3-47, 3-53
PCR Initial Value dialog box, 3-10
Performance conditions, A-1
PIT icon, 3-50
PLAY button, 2-2
PLAY commands, 3-88
Play menu, 3-5
Play Properties dialog box, C-10
Play/Record status indicator, 2-7
PMT icon, 3-47
Point-to-point connection, 3-126
Power connector, 2-5
Power cord options, 1-3, 1-4
Power cord requirements, 1-6
Preset file, 3-63
Printer connector, 2-5
Product description, 1-1

Q

Queries, 3-78

R

Rear-panel connectors, 2-4
REC button, 2-3
RECORD commands, 3-100
Record menu, 3-27
Record Properties dialog box, C-14
Related manual, xiv
Remote connection status icons, 2-10
ReMux
 application window, B-2
 Edit menu, B-6
 File menu, B-5
 menus, B-5
 ReMux menu, B-6
 tutorials, B-8
 View menu, B-8

- Window menu, B-7
- RRT icon, 3-50
- RST icon, 3-50
- Rules
 - command forming, 3-77
 - for using SCPI commands, 3-80

S

- Saving a preset file, 3-63
- Schedule property dialog box, C-16
- Scheduler
 - application window, C-2
 - File menu, C-5
 - menus, C-5
 - Schedule menu, C-6
 - schedule play mode, C-18
 - schedule record mode, C-21
 - tutorials, C-18
 - View menu, C-5
- SCPI
 - abbreviating, 3-79
 - chaining commands, 3-79
 - commands, 3-77
 - general rules, 3-80
 - parameter types, 3-78
- SCPI commands and queries syntax, 3-77
 - creating commands, 3-77
 - creating queries, 3-78
- Scroll bar, 2-9
- SDT icon, 3-50
- SDTT icon, 3-50
- Select File dialog box, 3-4
- Service options, 1-4
- Set Non-TS Sync dialog box, 3-9
- Setting Ethernet parameters, 3-68
- SIT icon, 3-50
- SMPTE310M/ASI/SPI interface (Option 07), 2-13
- SPI In/Out connector, 2-5
- ST icon, 3-50
- Standard accessories, 1-2
- Start/Stop Position dialog box, 3-11
- Starting the ReMux application, B-1
- Starting the Scheduler application, C-1
- Status dialog box, 3-25
- S-TMCC, xiii
- S-TMCC icon, 3-45
- STOP button, 2-3
- Stream menu (Scheduler), C-9
- STT icon, 3-51
- Syntax
 - command, 3-77
- SYSTEM commands, 3-104

T

- TAB button, 2-3
- Target dialog box, 3-27

- TDT icon, 3-50
- Timer Play/Record dialog box, 3-13
- Toolbar, 2-7
- Toolbar buttons, 3-34
- TOT icon, 3-50
- Transport stream icon, 3-46
- Trig In/Out connector, 2-4
- TSdT icon, 3-46
- Tutorials
 - outputting a transport stream, 2-20
 - recording a transport stream, 2-22
- TVCT icon, 3-50

U

- Univ I/F menu (Option 02 only), 3-20, 3-30
- Universal parallel/serial interface (Option 02), 2-12
- USB connectors, 2-1
- Utility menu, 3-22

V

- VGA connector, 2-5
- VIDEO icon, 3-48
- View menu, 3-4

